

Gas detector head GD-70D Series

Operating Manual

Request for the Customers

- Read and understand this operating manual before using the detector.
- You must operate the detector in accordance with the operating manual.
- Regardless of warranty period, we shall not make any compensation for accidents and damage caused by using this product.
The compensation shall be made only under the warranty policy of products or parts replacement.
- Because this is a safety unit, a regular maintenance for every six months and daily maintenance must be performed.
- If you find abnormalities in the detector, please notify them to our local representative immediately.

RIKEN KEIKI Co., Ltd.

2-7-6 Azusawa, Itabashi-ku, Tokyo, 174-8744, Japan

Phone : +81-3-3966-1113

Fax : +81-3-3558-9110

E-mail : intdept@rikenkeiki.co.jp

Web site : <http://www.rikenkeiki.co.jp/english/>

<Contents>

1	Overview	3
1-1.	Preface	3
1-2.	Purpose of use	3
1-3.	Definition of DANGER, WARNING, CAUTION, and NOTE	3
2	Important Notices on Safety	4
2-1.	Danger cases	4
2-2.	Warning cases	4
2-3.	<Precautions>	5
3	Product Components	6
3-1.	Product components	6
3-2.	Appearance	7
3-3.	Units description	7
3-4.	Block diagram	13
4	Installation	14
4-1.	Requirements	14
4-2.	Precautions for installation sites	14
4-3.	Precautions for system designing	15
4-4.	Installation of detector	17
4-5.	How to wire	20
4-6.	How to tube	26
5	How to Operate	27
5-1.	Preparation for start-up	27
5-2.	Basic operating procedures	28
5-3.	How to start the detector	29
5-4.	Modes	30
5-5.	Detection mode	31
5-6.	Alarm Test Mode	32
5-7.	User Mode	33
5-8.	How to exit	37
6	Detection Mode	38
6-1.	Gas alarm activation	38
6-2.	Fault alarm activation	40
6-3.	External output operation	41
6-4.	Other functions	43
7	Maintenance	47
7-1.	Maintenance intervals and items	47
7-2.	Regular Maintenance Mode	49
7-3.	Gas calibration method	65
7-4.	Other adjustments/Cleaning method	68
7-5.	How to replace parts	69
8	Storage, Relocation and Disposal	71
8-1.	Procedures to store the detector or leave it for a long time	71
8-2.	Relocate	71
8-3.	Disposal	72
9	Troubleshooting	73
10	Product Specifications	76
10-1.	Product specifications	76
10-2.	Standard Accessories	79
10-3.	Detection principle	79
11	Definition of Terms	86

1

Overview

1-1. Preface

Thank you for choosing our gas detector head GD-70D Series. Please check that the model number of the product you purchased is included in the specifications on this manual.



This manual explains how to use the detector and its specifications. It contains information required for using the detector properly. Not only the first-time users but also the users who have already used the product must read and understand the operating manual to enhance the knowledge and experience before using the detector.

1-2. Purpose of use

- This is a fixed type gas detector head which detects leak of gases used in semiconductor factories, etc.
- The gas detector is a safety unit, not an analyzer or densitometer which performs quantitative/qualitative analysis/measurement for gases. You must understand the features of the detector before using it, so that you can use it properly.
- The detector detects abnormalities in the air caused by presence of gases or other reasons (leak and oxygen deficiency) with the built-in gas sensor unit. The concentrations of detected gases are shown on the Character LCD.
- The built-in pump in the detector draws gas to perform gas detection.
- The detector has two-step gas alarm contact and fault alarm contact.
- The detector outputs gas concentration in 4 - 20 mA or digital data.

GD-70D	Analog Transmission (4-20 mA specification)
GD-70D-NT	2-wire type DC power-line communication (NT specification)
GD-70D-ET	Ethernet (ET specification)

1-3. Definition of DANGER, WARNING, CAUTION, and NOTE

 DANGER	Indicates an imminently hazardous situation which, if not avoided, will result in death or serious injury or serious damage to the product. The use of this symbol is to be limited to the most extreme situation.
 WARNING	Indicates a potentially hazardous situation which, if not avoided, could result in death or serious injury on the human body or object.
 CAUTION	Indicates a potentially hazardous situation which, if not avoided, may result in minor or moderate injury or some damage on the human body or objects. It may also be used to alert against unsafe practices.
NOTE	This means "ADVICE" at operation.

2

Important Notices on Safety

2-1. Danger cases



DANGER

This is not an explosion-proof unit. You must not use it to detect gases exceeding the lower explosive limit (LEL).

2-2. Warning cases



WARNING

Power Supply

Before turning on the detector, always check whether the voltage is properly applied. Do not use an unstable power supply because it may cause malfunctions.

Need of grounding circuit

Do not cut the grounding **circuit** or disconnect the wire from the grounding terminal.

Defects in protective functions

Before starting the detector, check the protective functions for defects. When seeming defects are found in the protective functions, such as protective grounding, do not start the detector.

External connection

Before connecting the detector to external equipments or external control circuit, securely connect it to a protective grounding circuit.

Tubing

The detector is designed to draw gases around it under the atmospheric pressure. If excessive pressure is applied to the sampling inlet and outlet (GAS IN, GAS OUT) of the detector, detected gases which may be leaked from its inside pose dangers. Be sure that excessive pressure is not applied to the detector when it is used. Detected gases must be exhausted from the detected gas exhausting outlet (GAS OUT) on the bottom of the detector to which an exhaust tube is connected, to a point regarded as a safe place.

Handling the sensor unit

Do not disassemble the electrochemical type sensor unit (ESU) or galvanic cell type sensor unit (OSU) because they contain electrolyte. Electrolyte may cause severe skin burns if it contacts skin, while it may cause blindness if its contacts eyes. If electrolyte is adhered on you clothes, that part on your clothes is discolored or its material is decomposed. If contact occurs, rinse the area immediately with a large quantity of water.

Zero adjustment (AIR Adjustment) in the atmosphere

When zero adjustment (AIR Adjustment for oxygen deficiency alarm) is performed in the atmosphere, check the atmosphere for freshness before beginning the adjustment. If other gases exist, the adjustment cannot be performed properly, thus leading to dangers when the gas leaks.

Operation in a gas

Do not operate the detector in a place where combustible gases or vapors are present. Operating the detector in such an environment will lead to extreme dangers.

Response to a gas alarm

Issuance of a gas alarm indicates that there are extreme dangers. Take proper actions based on your judgment.

2-3. <Precautions>



CAUTION

Do not use a transceiver (walkie-talkie) near the detector.

Radio wave from a transceiver near the detector or its cables may disturb commands. When using a transceiver, it must be used in a place where it disturbs nothing.

To restart the detector, you must wait five seconds more before doing it.

Restarting the detector within five seconds may cause errors.

Verify that the reading on the flow rate indicator corresponds to the specified flow rate before using the detector.

If it does not correspond to the specified flow rate, gas detection cannot be performed properly. Check whether the flow rate is unstable or lost.

Attach the dust filter before using the detector.

Before using the detector, attach the specified filter to prevent disturbances by possible gas adsorption or air dust. A dust filter to be used varies depending on the gas to be detected. For more information on dust filters, please contact our sales department.

Observe the operating restrictions to prevent condensation inside the tube.

Condensation formed inside the tube causes clogging or gas adsorption, which may disturb accurate gas detection. Thus, condensation must be avoided. In addition to the installation environment, carefully monitor the temperature/humidity of the sampling point to prevent condensation inside the tube. In particular, when detecting a gas which is dissolved into water and corrodes contacted materials, such as a strong acid gas, the gas is undetectable and furthermore may corrode internal parts. Please observe the operating restrictions.

Do not use the external output of the detector to control other units.

This is not a control unit. You are not allowed to use its external output to control other units.

Do not disassemble/modify the detector, or change the settings if not necessary.

Disassembling/Modifying the detector will invalidate the warranty of the performance. Changing the settings without understanding the specifications may cause alarm malfunctions. Please use the detector properly in accordance with the operating manual.

Do not forget to perform a regular maintenance.

Since this is a safety unit, a regular maintenance must be performed to ensure its safety. Continuing to use the detector without performing a maintenance will compromise the sensitivity of the sensor, thus resulting in inaccurate gas detection.

3

Product Components

3-1. Product components

<Gas Detector (GD-70D Series)>

<Standard Accessories>

- Operating manual
- Protective rubber cap (to be removed when using the detector)
- Dedicated handling lever (for wiring)
- Dust filter
- Interference gas removal filter (to be supplied with some sensor units)



<Pyrolyzer Unit (PLU-70) (Option)>

* This is needed in "pyrolyzer + electrochemical type (ESU)" and "pyrolyzer + pyrolysis-particle type (SSU)". For more information on the pyrolyzer unit (PLU-70), see the separate operating manual.

Pyrolyzer unit

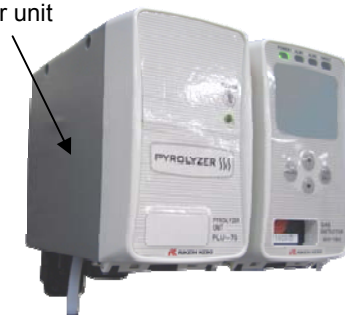

3-2. Appearance

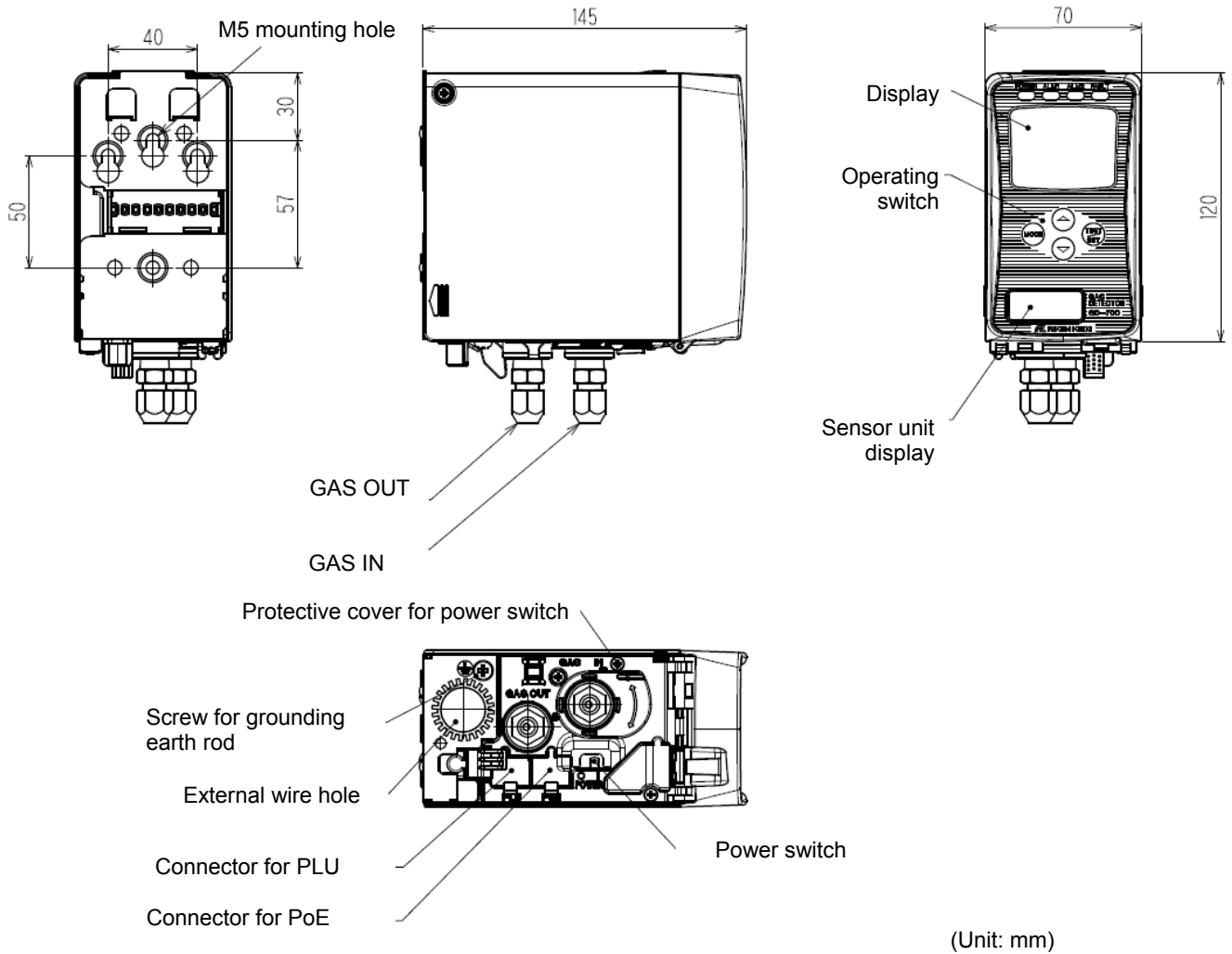

3-3. Units description

The detector consists of the following units.

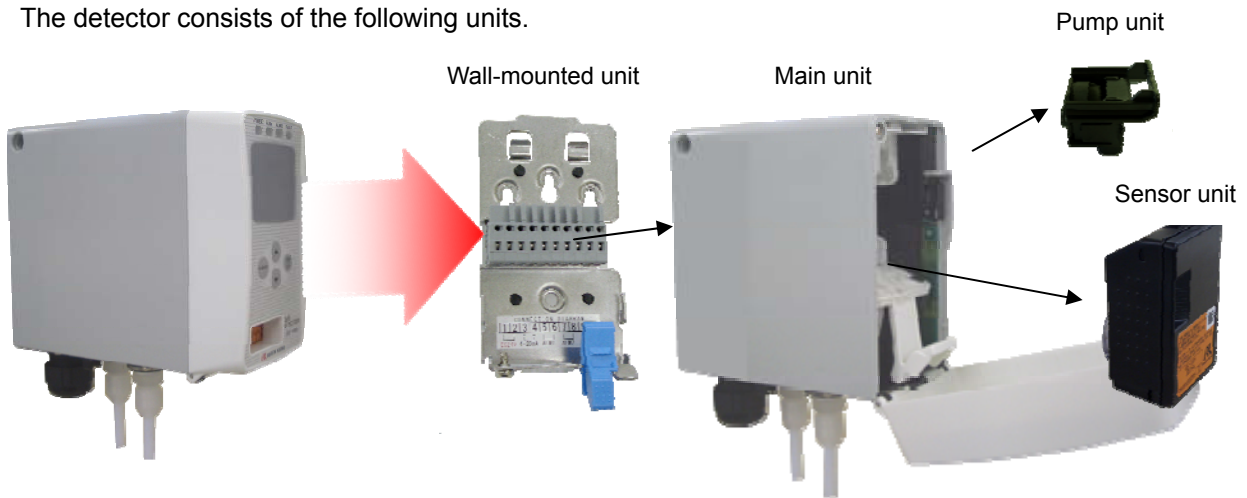

CAUTION

- Each unit consists of precision parts. When a unit is detached, be careful not to drop it. Dropping the unit compromises its original performance or causes malfunctions.

<Detaching and Attaching Main Unit>

Detaching Main Unit

While pushing the sky blue lock lever toward the wall-mounted unit, hold up the main unit.

If you cannot move the main unit, insert a larger flathead screwdriver while pushing the lock lever, and you can easily detach it as shown below. Do not rotate or move up and down the flathead screwdriver. Simply insert it into the wall-mounted unit.



Attaching Main Unit

At the position of 10 mm above the wall-mounted unit, press the main unit onto the wall-mounted unit. Be sure to fit both side hooks of the wall-mounted unit in the grooves of the main unit.

Then press down the main unit to fix it. The lock at the bottom of the main unit clicks to fix it properly. Make sure that the top center of the wall-mounted unit is above the main unit as viewed from front.

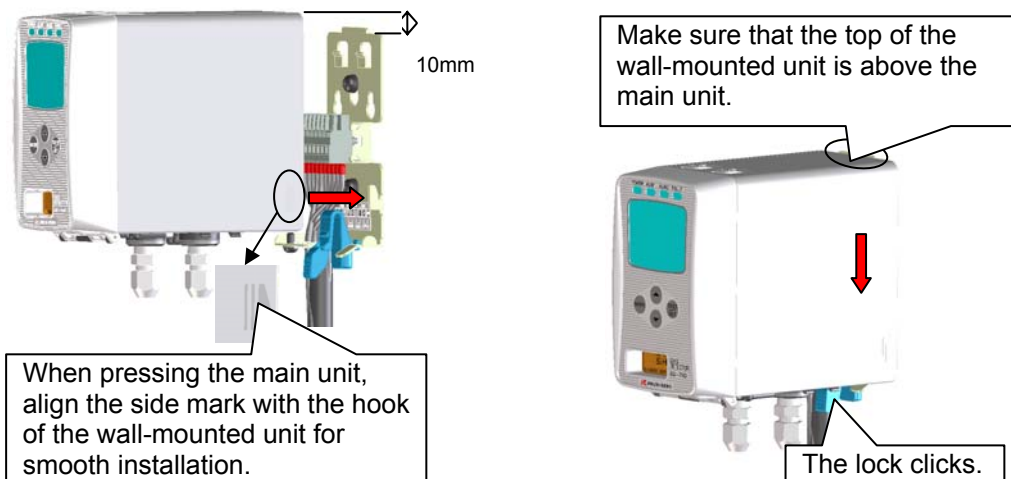

CAUTION

- Be careful not to drop the main unit when detaching it. Also, check the secure installation of the main unit after attaching it to the wall-mounted unit. If the main unit is not securely installed, it might fall, causing an unexpected injury or a damage of the unit.
- Turn the power off before detaching or attaching the main unit.

<Detaching and Attaching Sensor Unit>

1. Push the two buttons at the top of the main unit together to open the front cover. (Pushing only either one button cannot open the cover, but then pushing the other can open it.)
* The front cover opens about 90 degrees at first. You can push it down to 180 degrees.



CAUTION

- Turn the power off before detaching or attaching the sensor unit.

2. Hold the convexed parts on both sides of the sensor unit and pull it out.
If the sensor unit is hard to detach, insert a finger into the gap at the top right of the sensor unit and pull it out.
3. When attaching the sensor unit to the main unit, thrust it onto the main unit and make sure that the sensor unit is securely fixed, otherwise it might come off.
4. After replacing the sensor unit, close the front cover. Be sure to check the click of the front cover to fix it properly, otherwise it might open again.

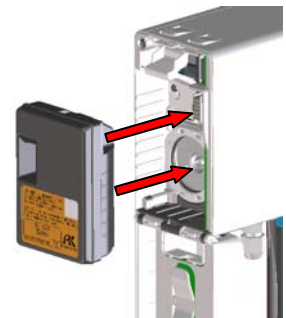
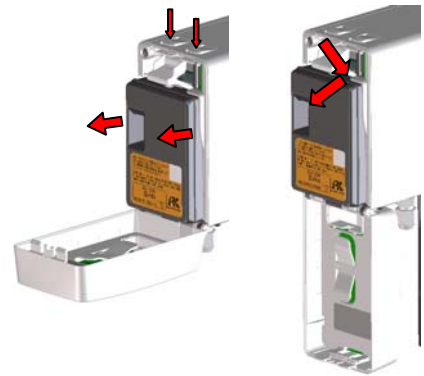

<Detaching and Attaching Pump Unit>

After detaching the sensor unit, push down to open the pump stopper. Pinch the part labeled "PULL" at the top of the pump unit, and pull it out.

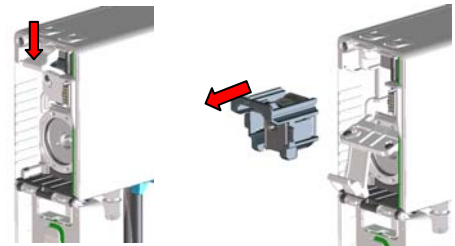

When attaching the pump unit to the main unit, position the grooves of the pump unit at the rails of the main unit and push the pump unit.
Do not push the center diaphragm. Push the part labeled "PULL".
And as the connecting point (flow path) of the pump unit is greased, be sure to check for any dust.

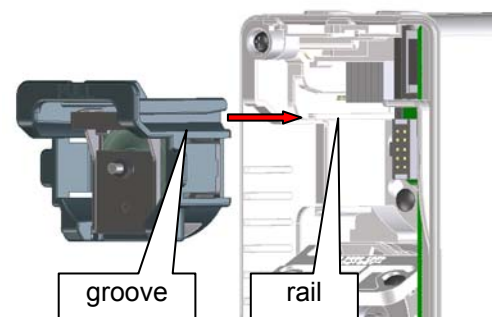
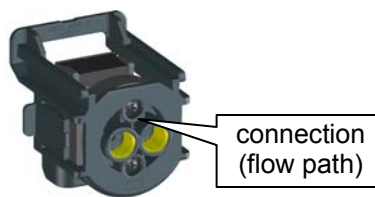
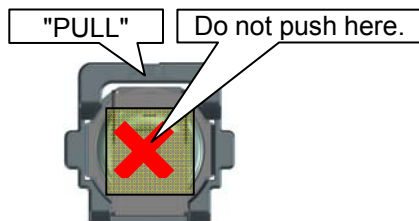

<Front Panel and Character LCD>

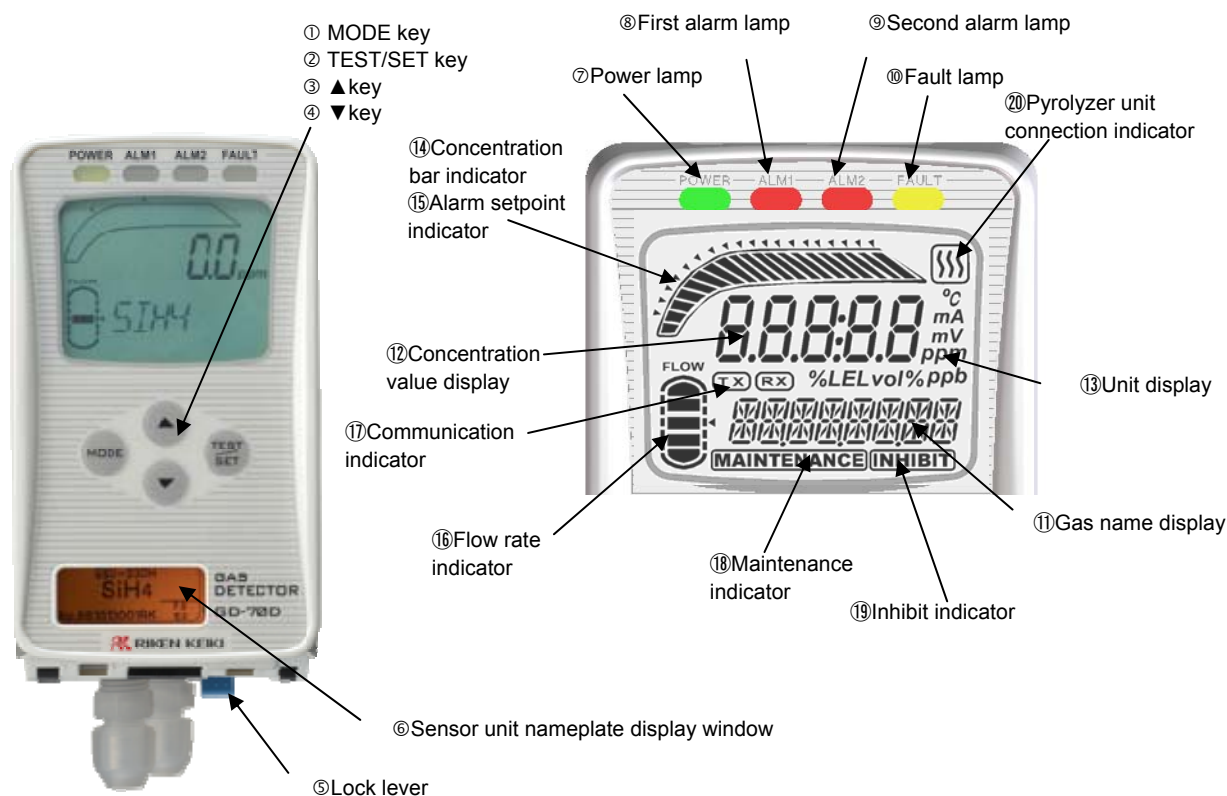

①	MODE key	Used to enter the maintenance mode. It is also used to cancel or skip in a specific mode.
②	TEST/SET key	Used to enter the test mode. It is used for value confirmation and so on in a specific mode.
③	▲ key	Used to switch screen or change a value (UP).
④	▼ key	Used to switch screen or change a value (DOWN).
⑤	Lock lever	Lever to lock the main unit. Push it to attach or detach the main unit.
⑥	Sensor unit nameplate display window	Window to look at the nameplate of the sensor unit. You can identify the currently attached sensor unit.
⑦	Power lamp (POWER)	Power lamp. It lights in green when the power is on.
⑧	First alarm lamp (ALM1)	First alarm lamp. It lights in red when the first alarm is reached.
⑨	Second alarm lamp (ALM2)	Second alarm lamp. It lights in red when the second alarm is reached.
⑩	Fault lamp (FAULT)	Fault lamp. It lights in yellow when an abnormality is detected in the detector.
⑪	Gas name display	Displays the gas name in chemical formula and so on (e.g. Silane = SiH ₄).
⑫	Concentration value display	Displays the gas concentration and so on.
⑬	Unit display	Displays the unit according to the specification (ppm, ppb, vol%, %, %LEL).
⑭	Concentration bar indicator	The detectable range (full scale = FS) is divided into 20 with bars. The increase in concentration is displayed in proportion to the full scale.
⑮	Alarm setpoint indicator	The alarm setpoints (AL1 and AL2) are indicated on the concentration bar.
⑯	Flow rate indicator	Displays the suction flow rate. The center of the bars means the normal suction flow rate of 0.5 L/min.
⑰	Communication indicator	For GD-70D-NT, this indicator is displayed while transmitting data with the upper unit (TX, RX).
⑱	Maintenance indicator	Displayed during the maintenance mode. When this indicator is displayed, the alarm contact is disconnected to be disabled.
⑲	Inhibit indicator	Displayed when the inhibition (point skip) is set.
⑳	Pyrolyzer unit connection indicator	Displayed when the dedicated pyrolyzer unit (PLU-70) is connected.

<Wall-mounted Unit>

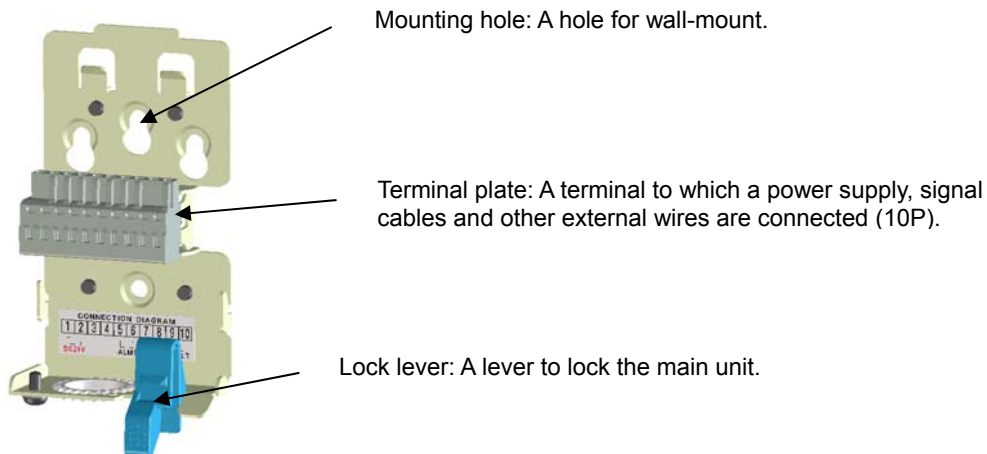

<How to Use Sensor Unit>

A sensor unit installed in the detector is the same regardless of the detection principle, thus sensor units are interchangeable. Each sensor unit has a different color in accordance with the principle as shown below. How to handle the sensor unit varies depending on its principle.



CAUTION





- The sensor unit must be handled carefully to ensure quality as safety unit. When the sensor unit is stored, a dedicated warehouse and power equipment for the sensor unit are needed. In principal, the sensor unit must not be detached from the detector when it is handled or stored. We will take care of your sensor unit.
- Be sure that the sensor unit is not installed improperly.
If a sensor unit of different specification or principle from the one shipped from the manufacturer, a message will be displayed on the LCD of the detector (C-02).
If the message is displayed, check the specifications of the sensor unit.
- After the sensor unit is replaced, always perform a gas calibration (zero adjustment and span adjustment).

Electrochemical type (ESU)



- Do not disassemble the sensor unit because it contains electrolyte. If contact occurs, rinse the area immediately with a large quantity of water.
- The sensor unit identifies the direction. Put the sensor unit in the dedicated case while handling it. Do not place it on its side or upside-down.
- When a new sensor unit is installed, it must be warmed up. Although warm-up time is different depending on the type of the installed sensor, it is recommended that warm-up should be performed for three hours or more. Please contact our sales department for more information.
- The sensor unit must be stored in a clean, cool and dark place away from direct sunlight. Some types of the sensor units cannot be stored together with other units. Please contact our sales department for more information.



<p><u>Pyrolysis-particle type (SSU)</u></p> 	<ul style="list-style-type: none"> Although the sensor unit contains radioactive materials, it is certified as a specified designing certification device, which is regarded as a device having no influences on health. Observe the "Safety Manual" which stipulates conditions for the certification. To dispose of the sensor unit, you must return it to us. You do not need to take any additional actions. The sensor unit contains a small amount of radioactive materials. Do not disassemble it, or dispose of it like other wastes. The sensor unit must be put into the dedicated case specified by us, and stored away from direct sunlight in a clean place where the temperature and humidity are maintained at a normal level and where appropriate measures are introduced to prevent it from being taken out easily. When the sensor unit is transported out of your factory, please use a transportation company which can handle specified designing certification devices (L-type packages). For more information, see the "Safety Manual".  <p>Dedicated case</p>																													
<p><u>New ceramic type (NCU)</u></p> 	<ul style="list-style-type: none"> Before using this sensor unit, it must be warmed up for two hours or more. The sensor unit must be stored under normal temperature/humidity in a clean place away from direct sunlight. 																													
<p><u>Semiconductor type (SGU)</u></p> 	<ul style="list-style-type: none"> Before using the sensor unit, it needs to be warmed up for a specified time. The sensor unit is warmed up sufficiently in our factory before it is delivered to you. Therefore, after you receive the sensor unit, please use it as soon as possible so that unpowered time is minimized. The warm-up (powered) time before using the sensor unit is related to the unpowered time. <table border="1" data-bbox="485 1288 1406 1615"> <thead> <tr> <th rowspan="2">Unpowered time</th> <th colspan="2">Suggested powered time</th> </tr> <tr> <th>SGU-8541 (H2)</th> <th>SGU (Others)</th> </tr> </thead> <tbody> <tr> <td>10 minutes or less</td> <td>10 minutes or more</td> <td>2 hours or more</td> </tr> <tr> <td>1 hour or less</td> <td>30 minutes or more</td> <td>2 hours or more</td> </tr> <tr> <td>24 hours or less</td> <td>1 hour or more</td> <td>4 hours or more</td> </tr> <tr> <td>72 hours or less</td> <td>4 hours or more</td> <td>24 hours or more</td> </tr> <tr> <td>10 days or less</td> <td>2 days or more</td> <td>2 days or more</td> </tr> <tr> <td>Less than 1 month</td> <td>7 days or more</td> <td>7 days or more</td> </tr> <tr> <td>Less than 3 months</td> <td>14 days or more</td> <td>14 days or more</td> </tr> <tr> <td>3 months or more</td> <td>1 month or more</td> <td>1 month or more</td> </tr> </tbody> </table> <ul style="list-style-type: none"> To store the sensor unit under unpowered state, it must be stored under normal temperature/humidity in a clean place away from direct sunlight. 	Unpowered time	Suggested powered time		SGU-8541 (H2)	SGU (Others)	10 minutes or less	10 minutes or more	2 hours or more	1 hour or less	30 minutes or more	2 hours or more	24 hours or less	1 hour or more	4 hours or more	72 hours or less	4 hours or more	24 hours or more	10 days or less	2 days or more	2 days or more	Less than 1 month	7 days or more	7 days or more	Less than 3 months	14 days or more	14 days or more	3 months or more	1 month or more	1 month or more
Unpowered time	Suggested powered time																													
	SGU-8541 (H2)	SGU (Others)																												
10 minutes or less	10 minutes or more	2 hours or more																												
1 hour or less	30 minutes or more	2 hours or more																												
24 hours or less	1 hour or more	4 hours or more																												
72 hours or less	4 hours or more	24 hours or more																												
10 days or less	2 days or more	2 days or more																												
Less than 1 month	7 days or more	7 days or more																												
Less than 3 months	14 days or more	14 days or more																												
3 months or more	1 month or more	1 month or more																												
<p><u>Galvanic cell type (OSU)</u></p> 	<ul style="list-style-type: none"> Do not disassemble the sensor unit because it contains electrolyte. If contact occurs, rinse the area immediately with a large quantity of water. The sensor unit must be stored under normal temperature/humidity in a clean place away from direct sunlight. 																													

3-4. Block diagram

<Electric Diagram>

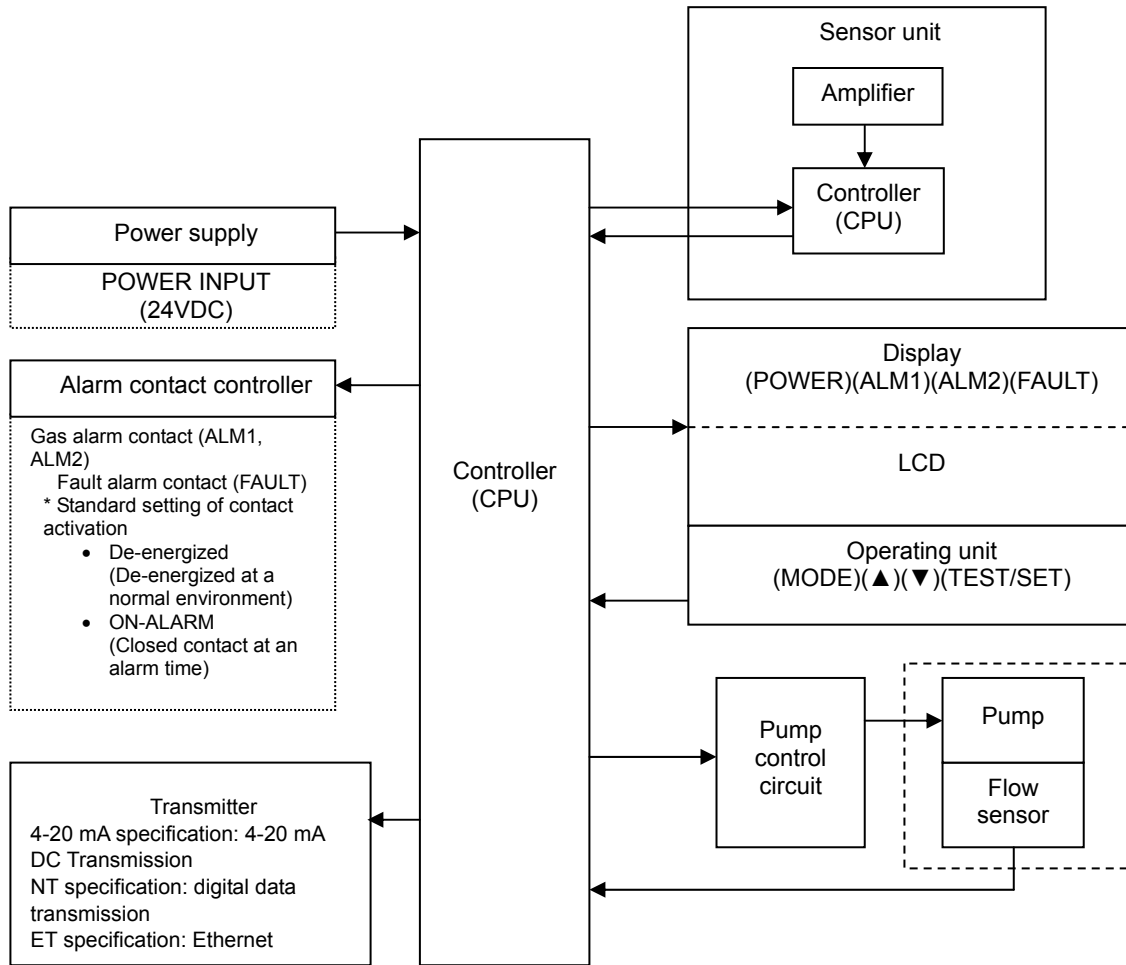

<Tubing Diagram>

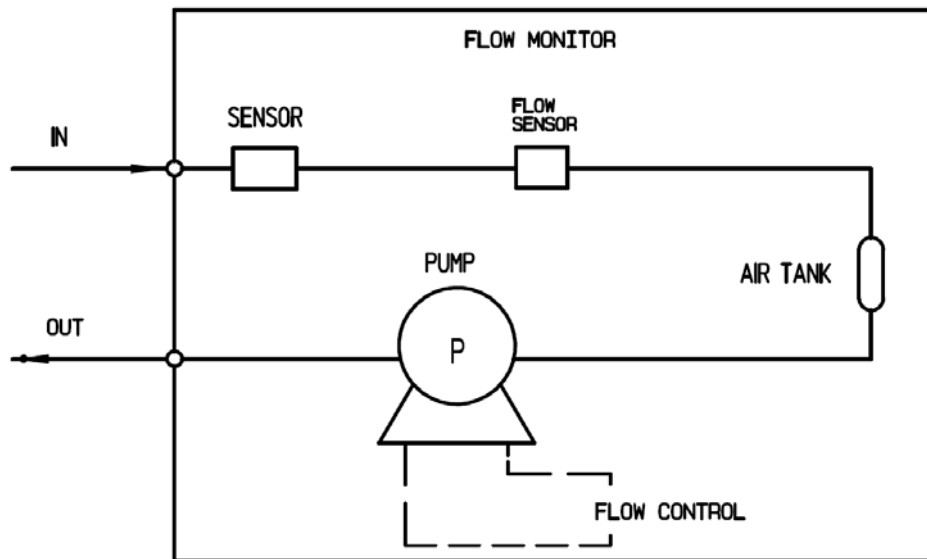

4

Installation

4-1. Requirements

Not only the first-time users but also the users who have already used the product must follow the operating precautions. Ignoring the precautions may damage the detector, resulting in inaccurate gas detection.



CAUTION

- After you received the detector, start using the detector within the specified operation start limit of the sensor unit.

4-2. Precautions for installation sites



CAUTION

- This is a precision instrument. Because the detector may not provide the specified performance in some places (environments), check the environment in the installation site, and then take appropriate actions if necessary.
- Because the detector plays an important role for safety and disaster prevention, you must install as many units of the detector as needed in appropriate points.
- Because the points where gases leak and remain easily are different depending on the types of gases and the working areas, please decide carefully installation sites and the number of units to be installed.

Do not install the detector in a place with vibrations or shocks.

The detector consists of sensitive electronic parts. The detector must be installed in a stable place without vibrations or shocks and it cannot drop.

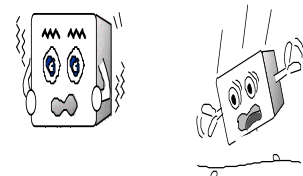

Do not install the detector in a place exposed to water, oil or chemicals.

When you select installation sites, avoid a place where the detector is exposed to water, oil or chemicals.



Do not install the detector in a place where the temperature drops below 0°C or rises over 40°C.

The operating temperatures of the detector are 0 - 40°C. The detector must be installed in a stable place where the operating temperatures are maintained and do not change suddenly.

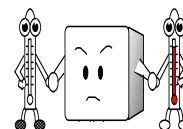

Do not install the detector in a place exposed to direct sunlight or sudden changes in the temperature.

When you select installation sites, avoid a place where it is exposed to direct sunlight or radiant heat (infrared rays emitted from a high-temperature object), and where the temperature changes suddenly. Condensation may be formed inside the detector, or the detector cannot adjust to sudden changes in the temperature.

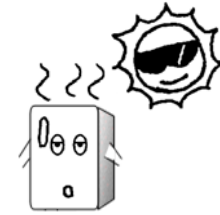

Keep the detector (and its cables) away from noise source devices.

When you select installation points, avoid a place where high-frequency/high-voltage exist.

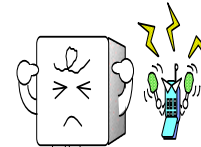

Do not install the detector in a place where maintenance of the detector cannot be performed or where handling the detector involves dangers.

Regular maintenance of the detector must be performed.

Do not install the detector in a place where the equipment must be stopped when maintenance is performed in its inside, where parts of the equipment must be removed to perform maintenance, or where the detector cannot be removed because tubes or racks prevent access to it. Do not install the detector in a place where maintenance involves dangers, for example, near a high-voltage cable.

Do not install the detector in equipment which is not properly grounded.

Before installing the detector in equipment, the equipment must be grounded properly.

Do not install the detector in a place where other gases exist around it.

The detector must not be installed in a place where other gases exist around it.

4-3. Precautions for system designing



CAUTION

- An unstable power supply and noise may cause malfunctions or false alarms. The descriptions in this section and each System Construction Manual must be reflected on the designing of a system using the detector.

Using a stable power supply

The external output and alarm contact of the detector may be activated when the power is turned on, when momentary blackout occurs, or when the system is being stabilized. In such cases, use a safety power supply, or take appropriate actions on the receiving side.

The detector must be provided with the following power supply.

Power supply voltage	24VDC±10% (the terminal voltage of the detector) or PoE connection (GD-70D-ET)	
Allowed time of momentary blackout	Up to 10 millisecond (To recover from the momentary blackout for 10 millisecond or more, restart the detector.)	Example of actions To ensure continuous operation and activation, install a protective power supply outside the detector.
Others	Do not use it with a power supply of large power load or high-frequency noise.	Example of actions Use a line filter to avoid the noise source if necessary.

Heat radiation designing

When it is installed in the closed instrumentation board, attach ventilation fans above and below the board.

Introducing protective measures against lightning

If cables are installed outside the factory/plant, or if internal cables are installed in the same duct as the cables coming from outside the factory/plant, "lightning" will cause problems. Because lightning acts as a large emission source while cables act as a receiving antenna, devices connected to the cables may be damaged.

Lightning cannot be prevented. Cables installed in a metal conduit or under the ground cannot be completely protected from inductive lightning surge caused by lightning. Although complete elimination of disasters caused by lightning is impossible, the following protective measures can be taken.

Protection against lightning	<p>Take appropriate measures in accordance with the importance of the facilities and the environment.</p> <ul style="list-style-type: none"> • Connect the transmission signal route by using optical fiber. • Provide protection by a lightning arrester (cable safety retainer). (Although inductive lightning surge can be transmitted through the cable, it is prevented by installing a lightning arrester before the field devices and central processing equipment. For information on how to use a lightning arrester, please contact the manufacturer.)
Grounding	In addition to lightning, there are more sources of surge noise. To protect units from these noise sources, the units must be grounded.

* The lightning arrester has a circuit to remove a surge voltage which damages field devices, so that signals may be attenuated. Before installing a lightning arrester, verify that it works properly.

Proper use of alarm contact

The alarm contact of the detector is used to transmit signals to activate an external buzzer, alarm lamp or rotating lamp. Do not use the detector for controlling purpose (e.g., controlling the shutdown valve).



CAUTION

- The "b" contact (break contact) under de-energized state may be opened momentarily by a physical shock, such as external force.
- When the "b" contact is selected for the alarm contact, take appropriate actions to prepare for a momentary activation, for example, add signal delay operation (approximately one second) to the receiving side of the "b" contact.

The specifications for the alarm contact of the detector are based on the resistant load conditions. If inductive load is used at the alarm contact, the following errors will occur easily because counter electromotive force is generated at the contact.

- Deposition, defective insulation or defective contact at the relay contact
- Damage of any electric parts due to high-voltage generated inside the detector
- Abnormal operations by an out-of-control CPU



CAUTION

- In principal, do not activate inductive load at the alarm contact of the detector. (In particular, never use the inductive load to activate a fluorescent lamp or motor.)
- If inductive load is activated, relay it with an external relay (contact amplification). However, because the coil of an external relay also involves inductive load, select a relay at a lower voltage (100 VAC or below), and then protect the contact of the detector with an appropriate surge absorbing part, such as a CR circuit.

If load is to be activated, appropriate measures must be taken to stabilize the operation of the detector and protect the alarm contact referring to the following information.

- Relay it with an external relay at a lower voltage of 100 VAC or below (contact amplification). At the same time, the surge absorbing part SK1 suitable for the specifications must be attached to the external relay.
- In addition, the surge absorbing part SK2 must be attached to the loaded side of the external relay if necessary.
- It may be recommended that the surge absorbing part should be attached to the contact for certain load conditions. It must be attached to an appropriate position by checking how the load is activated.

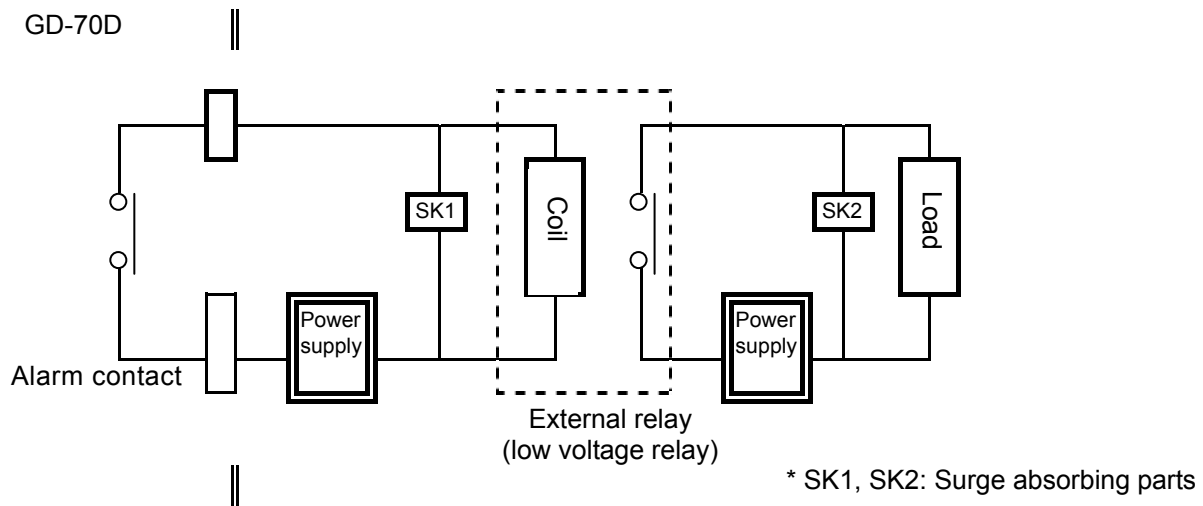

4-4. Installation of detector

NOTE

To use the pyrolyzer unit (PLU-70), also refer to the separate operating manual.



CAUTION

- Before installing the detector, remove the protective rubber caps from GAS IN and GAS OUT. If the detector turned on with the rubber caps remaining while the installation, applied overload may damage the pump and sensor. Do not forget to remove the caps.

<Install Dimension and Maintenance Space>

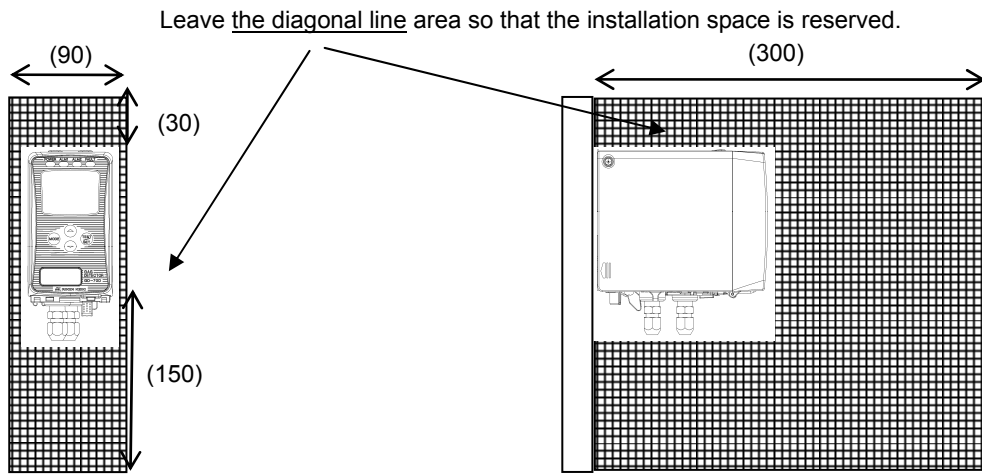

When installing by using 2 screws

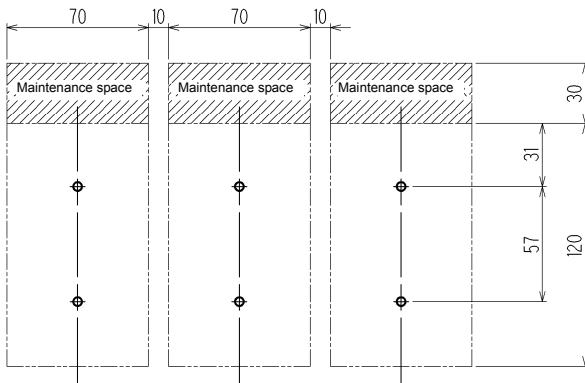

When installing by using 3 screws

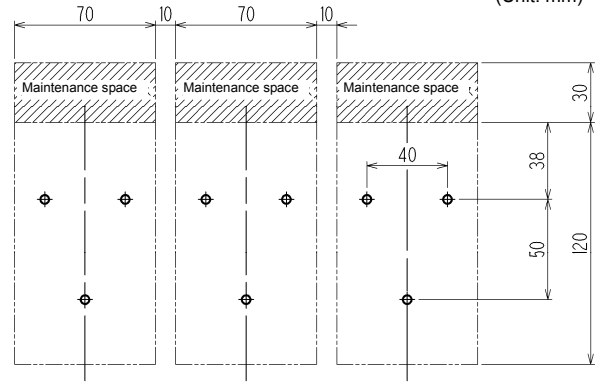

(Unit: mm)



CAUTION

- It is recommended that installation points should be away from each other for 10 mm or more. Intervals between installation points must be at least 5 mm.
- When you install more than one unit of the detector in a line, install them in a rack or wall that are not influenced by vibrations.
When the detectors are installed side-by-side, if the rack or wall in which the detectors are installed do not have enough strength, vibrations from the pumps inside the detectors cause resonance between them. In this case, take preventive actions, for example, reinforcing the rack or wall.



CAUTION

- The detector must be installed in the right direction to ensure its performance. Install the detector as shown on the following example, and adjust its position so that it is placed horizontally. (* The direction of the detector must also be kept during transportation, including when it is removed temporarily or relocated.)

<Right Installation Direction>

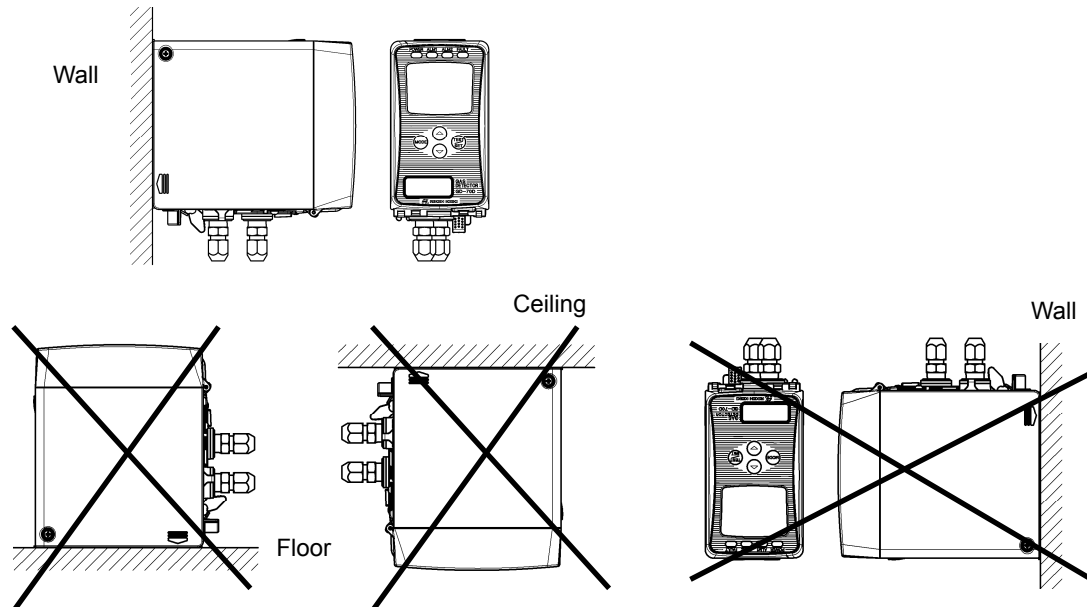

<Installation of Wall-mounted Unit>

Attach the wall-mounted unit in the installation surface using two or three M5 screws.

Recommended mounting screw (M5)
 Length of 8 mm or more
 Flat washer of $\Phi 10$ mm or less (small round)

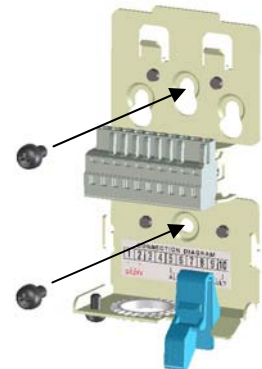

After the wall-mounted unit is attached to the wall, install the main unit in the wall-mounted unit.



CAUTION

- Install the unit so that its surface is in intimate contact with the wall-mounted unit. A space between the unit and the wall-mounted unit may invite unnecessary vibrations and noises.

4-5. How to wire

NOTE

To use the pyrolyzer unit (PLU-70), also refer to the separate operating manual.



CAUTION

- Be careful not to damage the internal electronic circuit when wiring. In addition, be careful not to apply stresses on the detector when (overweight) cables are installed.
- The power cables and signal cables must not be installed together with the motor power cables, etc. When these cables must be installed together for unavoidable reasons, put the power cables and signal cables in a metal conduit. The conduit must be connected to a grounding circuit.
- When stranded wires are used, prevent wires from contacting each other.
- Use the dedicated handling lever to wire.

<Recommended Cable>

For 3-wire type 4 - 20 mA (common cable for power and signal)	Shielded cable of CVVS, etc. (1.25sq) - 3-core
For 2-wire type 4 - 20 mA (power and signal cables separated)	Power: Cable of CVV, etc. (1.25sq) - 2-core Signal: Shielded cable of CVVS, etc. (1.25sq) - 2-core
For 2-wire type DC power-line communication system (NT)	Shielded twisted-pair cable of KPEV-S, etc. (1.25sq) - 1P
For Ethernet (ET)	Power: Cable of CVV, etc. (1.25sq) - 2-core Signal: Ethernet cable (category 5 or higher)
For PoE (ET)	Ethernet cable (category 5 or higher)
For contact	Cable of CVV, etc. (1.25sq) - max. 6-core

<Figure of Terminal Plate>

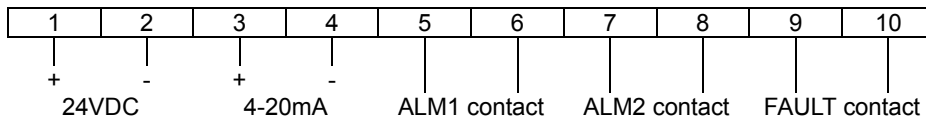

NOTE

For the 3-wire type (4 - 20 mA), the terminal 2 is used for common, and the terminals 2(-) and 3(+) are used to output 4 - 20 mA.

For the NT specification, the terminals 3 and 4 are not used.

For ET specification with PoE connection, the terminals 1 and 2 are disabled (Connection prohibited).

<Specifications of Terminal Plate>

Specifications of terminal plate

- Rated voltage: 250 VDC
- Rated current: 16 A

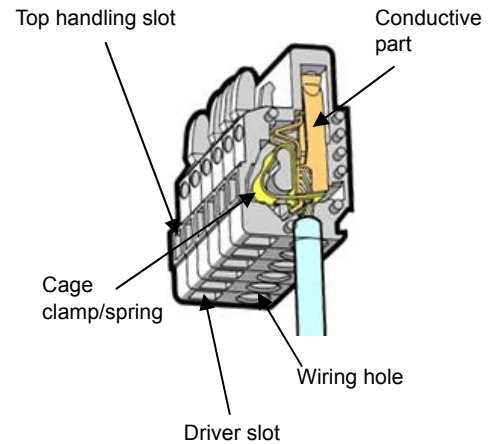

Connection conditions

- Cable: 0.08 - 2.5mm²
- Bare wire length: 8 - 9 mm
- Connecting tool: Dedicated handling lever (accessory)



CAUTION

- The specified bare wire length must be observed when the wire insulation is peeled off.
- Improper clamping of the wire due to a shorter bare wire length may cause defective electrification or heating.
- Damaging the wire insulation due to a shorter bare wire length may cause defective electrification or heating.
- Exposing the wire due to a longer bare wire length may cause defective insulation or a short circuit.
- Be careful not to break up the wire. If the wire is broken up when inserted to the terminal, this may cause defective insulation or heating.

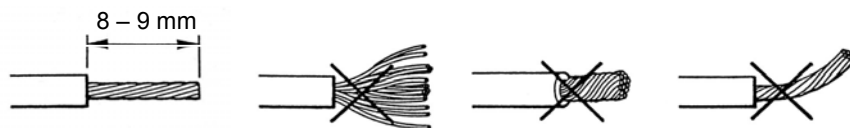

Compatible bar terminal

For a bar terminal, the following items are available.

- Bar terminal (ferrule): Model 216 Series (manufactured by WAGO)
- Crimping tool: Model VarioCrimp 4 (206-204) (manufactured by WAGO)



CAUTION

- A bar terminal of the specified model must be used. Using other bar terminals invalidates the warranty of the performance.

<How to Connect to Terminal Plate>

When cables are connected to the connectors, use the dedicated lever or a flathead screwdriver to do it as shown below.



CAUTION

- The right tools must be used.
- In principal, one wire can be connected to one wiring hole.
- When the wire is inserted into the driver slot by mistake, it does not contact the conductive part. This may cause defective electrification or heating.
- When the wire is inserted under the spring by mistake, it does not contact the conductive part. This may cause defective electrification or heating.

NOTE

How to Use the Dedicated Handling Lever

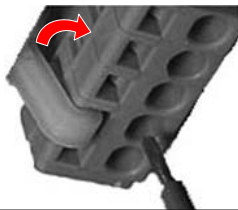

Push the lever with your finger to lower the spring in its inside.



While holding down the lever, insert the wire into the (round) wiring hole until it reaches the deepest point. Once the lever is released, the wire is secured.

To check whether the wire is connected securely, pull the wire gently. (Do not pull the wire strongly.)

<How to Clamp Cables>

Insert the supplied fastening-band to the hole on the wall-mounted unit as shown in the figure. Position the band so that its coarse side faces the wire. After inserting the fastening-band, fix the wire together.

NOTE

When an optional cable ground is used, it must be attached to the external wiring hole.



Push the dedicated handling lever to open the terminals, into which you can insert wires (one wire to one terminal).

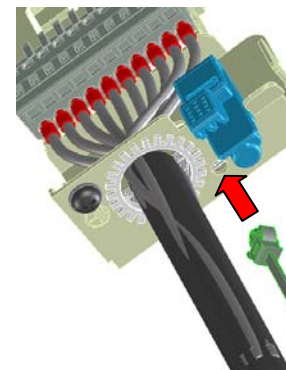
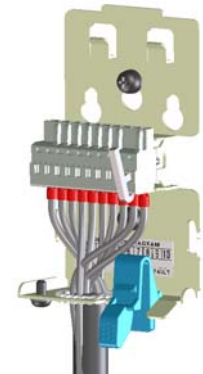
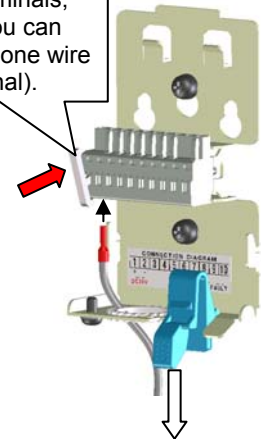

Position the band so that its coarse side faces the wire.

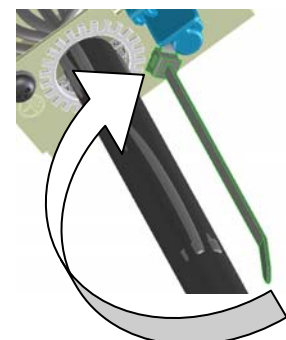

Grounding

Connect the detector to your grounding terminal.



WARNING

- Before turning on the detector, do not forget to connect it to a **grounding** terminal.
- For stable operation of the detector and safety, it must be connected to a grounding terminal. Do not connect the grounding wire to a gas pipe. The grounding must be made as D type grounding (below 100 Ω of grounding resistance).

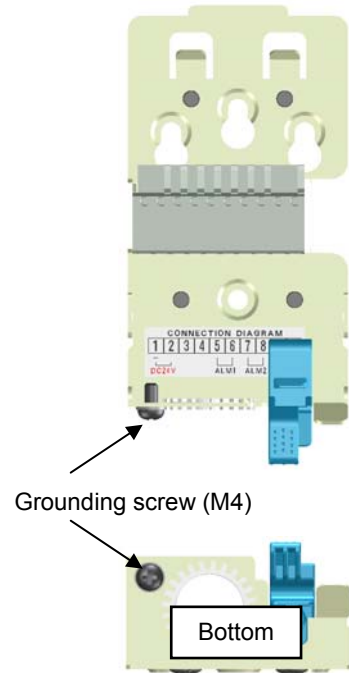

<How to Use Communication Connectors>

When using the detector in combination with the pyrolyzer unit (PLU-70) (option) or GD-70D-ET, connect the detector to each of them by inserting a cable into a communication connector on the bottom of the main unit.

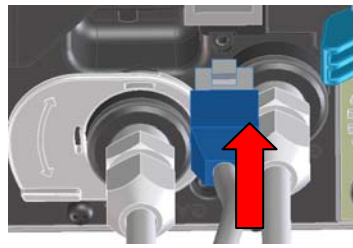
Dedicated communication cable for PLU-70	Dedicated communication cable connector (See the operating manual for PLU-70)
Ethernet cable	RJ45 connector 

NOTE

<Removal of Communication Connector Covers>

- Insert a small flathead screwdriver into a gap where the lug of the communication connector cover is protruding, and pull it up in the direction of an arrow in the figure to remove it. Be careful not to damage the connector pins inside by pushing in the flathead screwdriver.
- The communication connector cover is a one-piece component of covers for a dedicated communication cable for the PLU and an Ethernet cable. Since the cover can be easily split, use it in a way that suits your needs. Keep the cover attached to the connector while it is not connected.
- When you attach the cover, first fit the lug to the main unit and then push in the cover.

Wiring Example
Connecting to the indicator
(3-wire type - 4 - 20 mA specification)

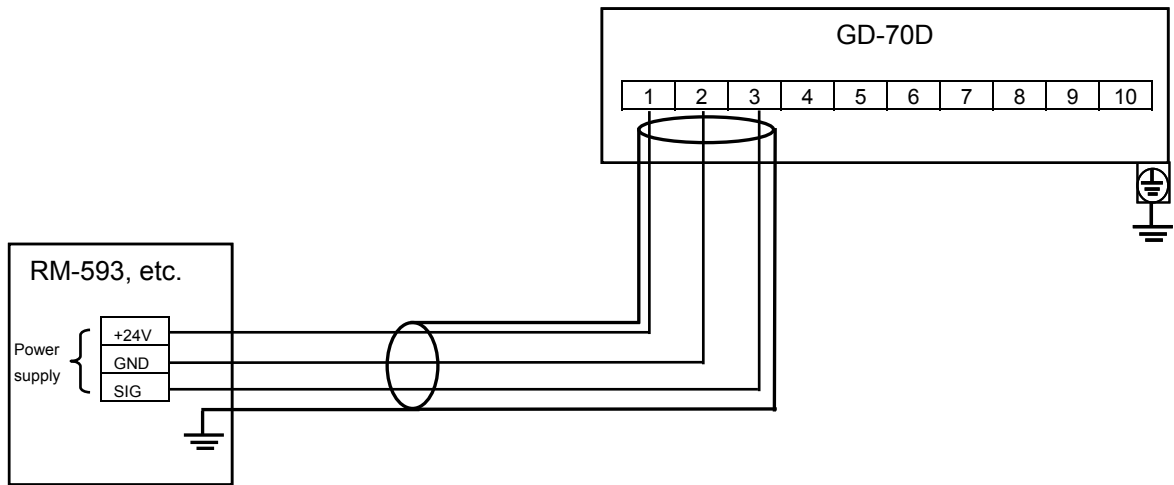

Connecting to the upper unit (DCS, PLC)
(2-wire type - 4 - 20 mA specification)

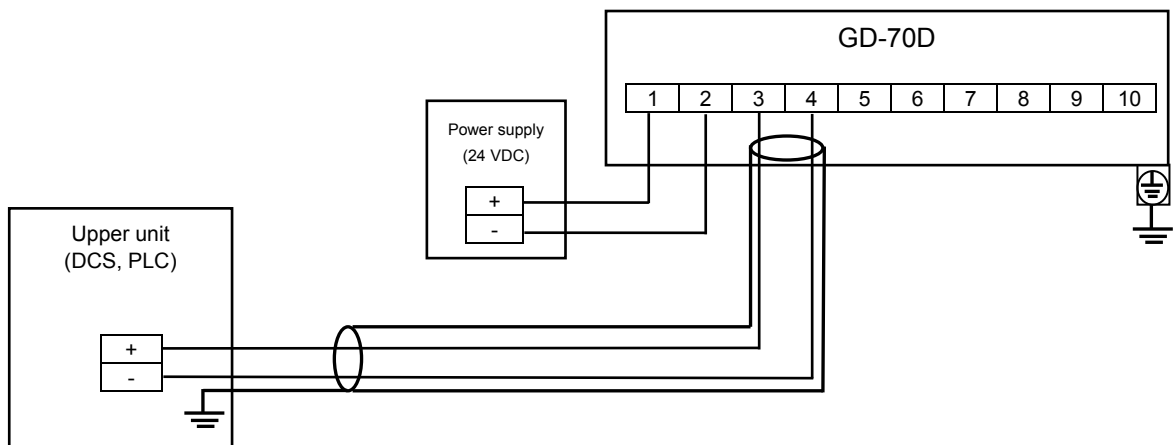

Connecting to the multi-display unit (RM-70NT)
(NT specification)

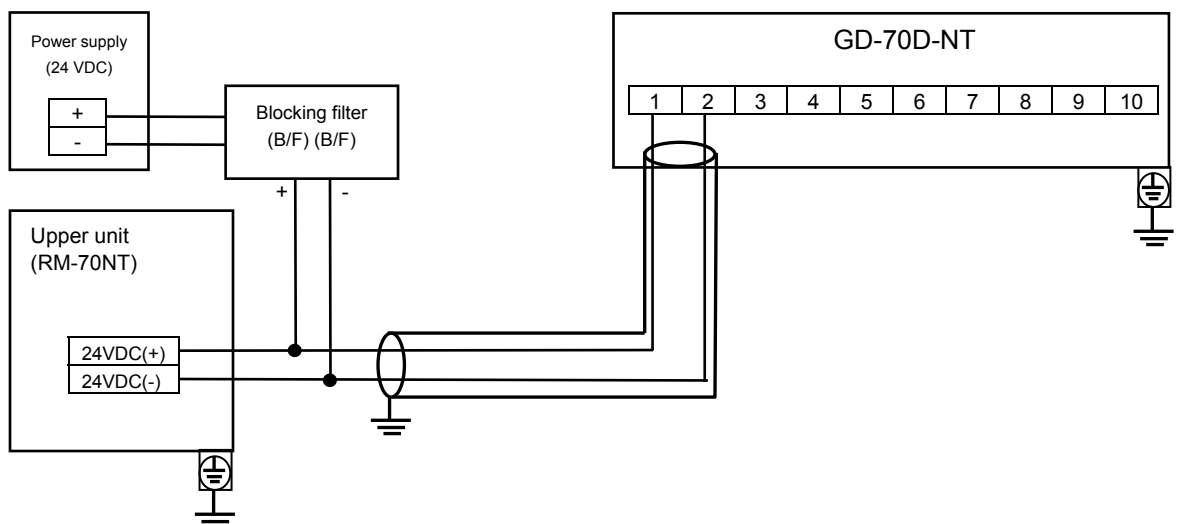

**Connecting to the upper unit (PC, PLC)
(Ethernet connection - ET specification)**

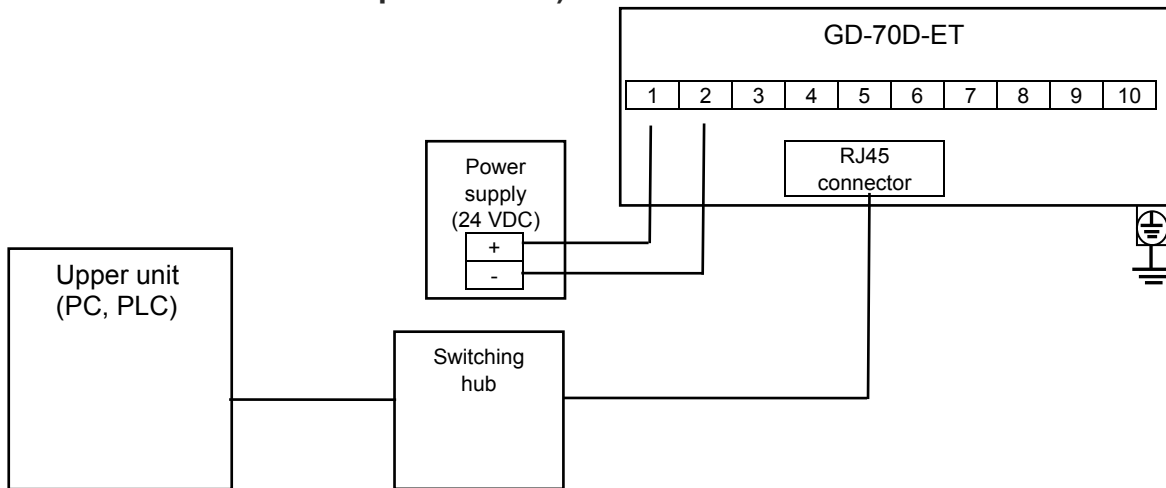

**Connecting to the upper unit (PC, PLC)
(PoE connection - ET specification)**

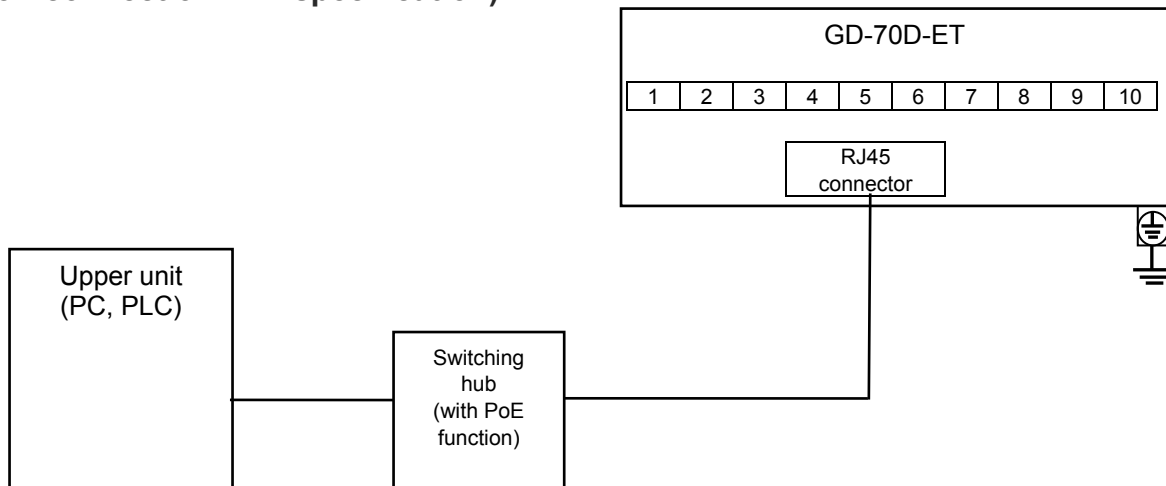

CAUTION

- Do not supply power simultaneously via PoE supply and 24V power supply (terminals 1 and 2).

4-6. How to tube

NOTE

To use the pyrolyzer unit (PLU-70), also refer to the separate operating manual.

The detector has a Rc1/4 thread inside of the sampling inlet/outlet (GAS IN, GAS OUT), to which "polypropylene" unions are normally attached. Because their material varies depending on the gas to be used, please specify the gas.

The compatible tube is a Teflon tube of $\Phi 6$ (OD) - $\Phi 4$ (ID). The tube must be installed with the supplied inners and sleeves attached to prevent a leak.

When the tube is cut, its cut point has a smaller inner diameter. Use an abrasive material to expand the cut point to the inner diameter. To remove cut-dust remaining inside of the tube, blow compressed air into the tube before connecting it to the detector. Some sample gases have highly adsorptive or corrosive property. Select the tube material taking into account of these precautions. The suction flow rate of the detector itself is approximately 0.5 L/min under the operating temperatures. When a gas is drawn from a distant point, please consult us on the tube length.

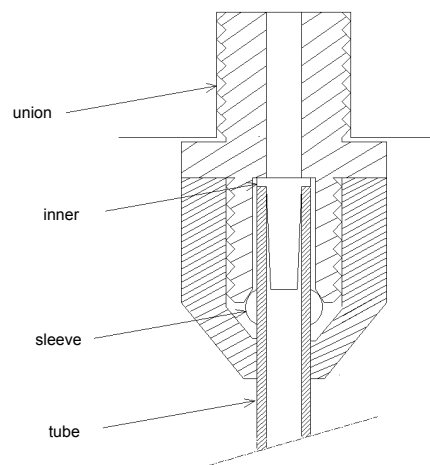

WARNING

- The detector is designed to draw gases around it under the atmospheric pressure. If excessive pressure is applied to the sampling inlet and outlet (GAS IN, GAS OUT) of the detector, detected gases may be leaked from its inside, thus leading to dangers. Be sure that excessive pressure is not applied to the detector while used.
- Detected gases must be exhausted from the detected gas exhausting outlet (GAS OUT) on the bottom of the detector to which an exhaust tube is connected, to a point regarded as a safe place.



CAUTION

- The longer the tube of the GAS IN is, the longer it takes for a gas to reach the detector. Because some gases have a highly adsorptive property for the tube, resulting in a slow response and a lower reading than the actual value, the length of the GAS IN tube must be minimized.
- When the humidity in the sampling point is high, condensation may be formed inside of the tube. Make sure to avoid condensation when using a gas which is dissolved into water and corrodes contacted materials, such as a strong acid gas, because it is undetectable and furthermore may corrode internal parts. Also avoid an excessive U-shaped or V-shaped tube piping.
- Determine the inlet for the sample gas, considering the air flow of the sample gas line and the gas generating process.
- To remove dust, do not forget to attach the supplied dust filter in the middle of the tube.
- You need to decide the length and material of the tube. Please contact our sales department for more information.

5

How to Operate

5-1. Preparation for start-up

Before connecting a power supply, read and understand the following precautions. Ignoring these precautions may cause an electric shock or damage the detector.

- Connect the detector to a grounding circuit.
- Check whether the wiring is connected to external circuit properly.
- Check whether the power supply voltage is compliant with the specification.
- Because the external contact may be activated during the adjustment, take measures to prevent an activated contact from having influences on external circuits.
- Check that there is no clogging or leak in the connected tube. (If the connected tube is clogged, pressure is applied to the sensor unit, causing errors and malfunctions. Note that the reading is fluctuated in the galvanic cell type, which may result in a false alarm.)
- Check that the filter is attached correctly. (The filter is specified based on the gas to be detected.)

5-2. Basic operating procedures

Normally, the detection mode is activated after the power is turned on.

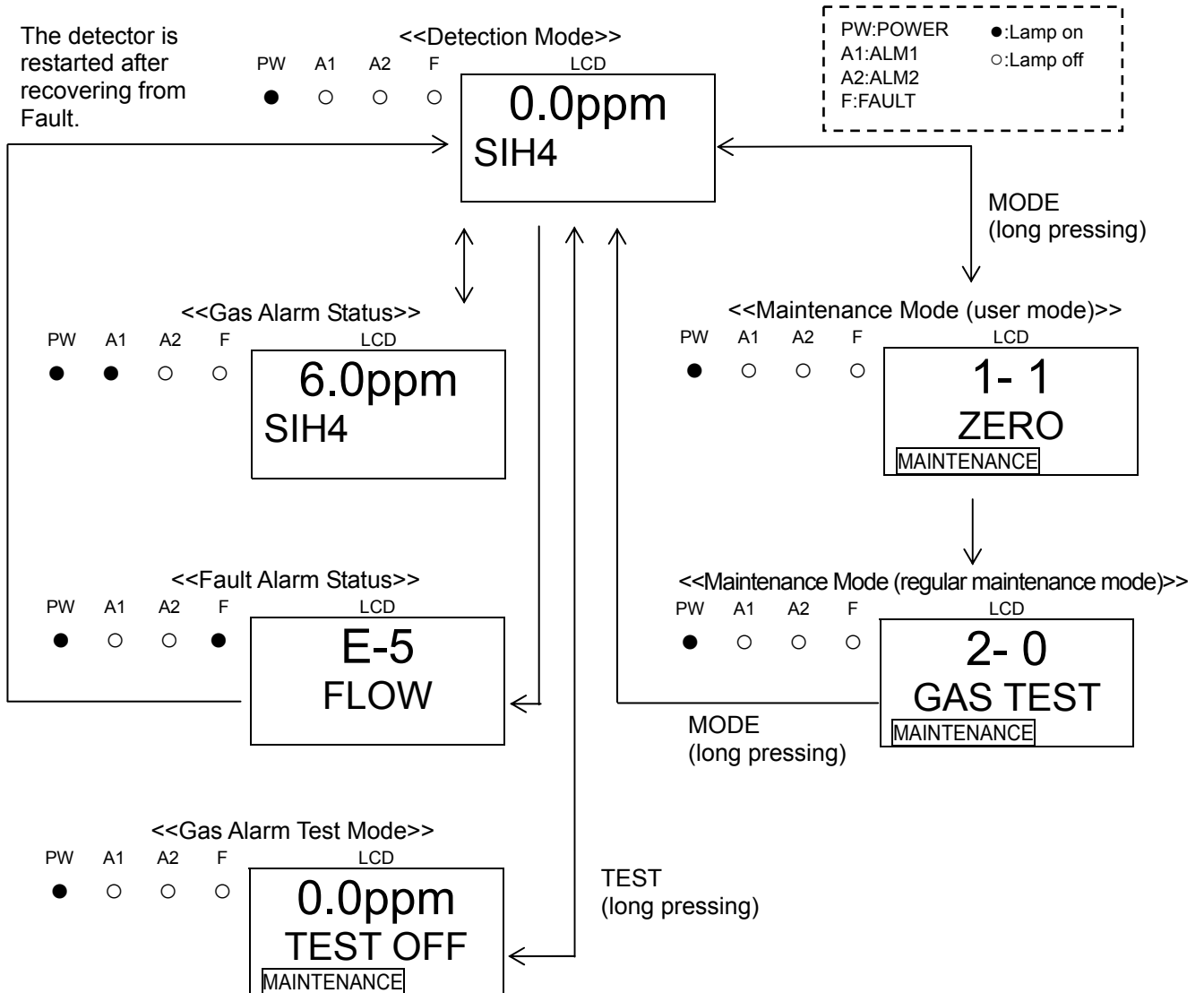

WARNING

- When the detector enters each mode from the detection mode while an alarm is activated, the alarm contact is released.

5-3. How to start the detector

- Before turning on the power switch, check whether the detector is installed properly.
- The power switch is protected by a cover to prevent access to it in a normal time. To turn ON/OFF the power switch, rotate the switch cover. (Return the switch cover to the original position after the switching is completed.)
- Turn ON the power switch.
- After the detector completes the start-up, it enters the detection mode.

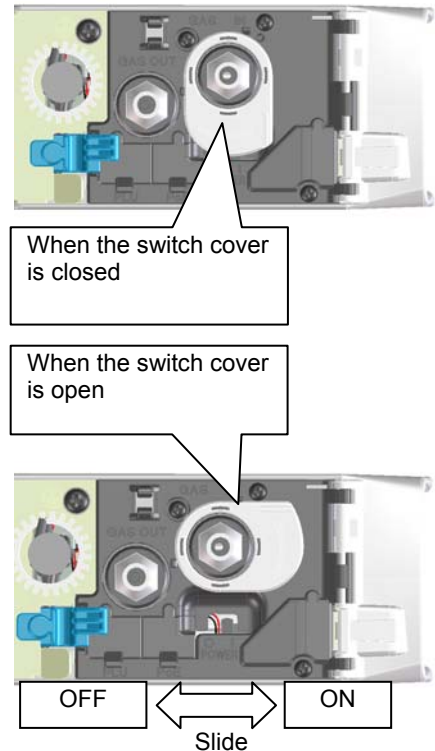

<Start-up Procedures (approximately 25 seconds for system check of the detector and alarm deactivation)>

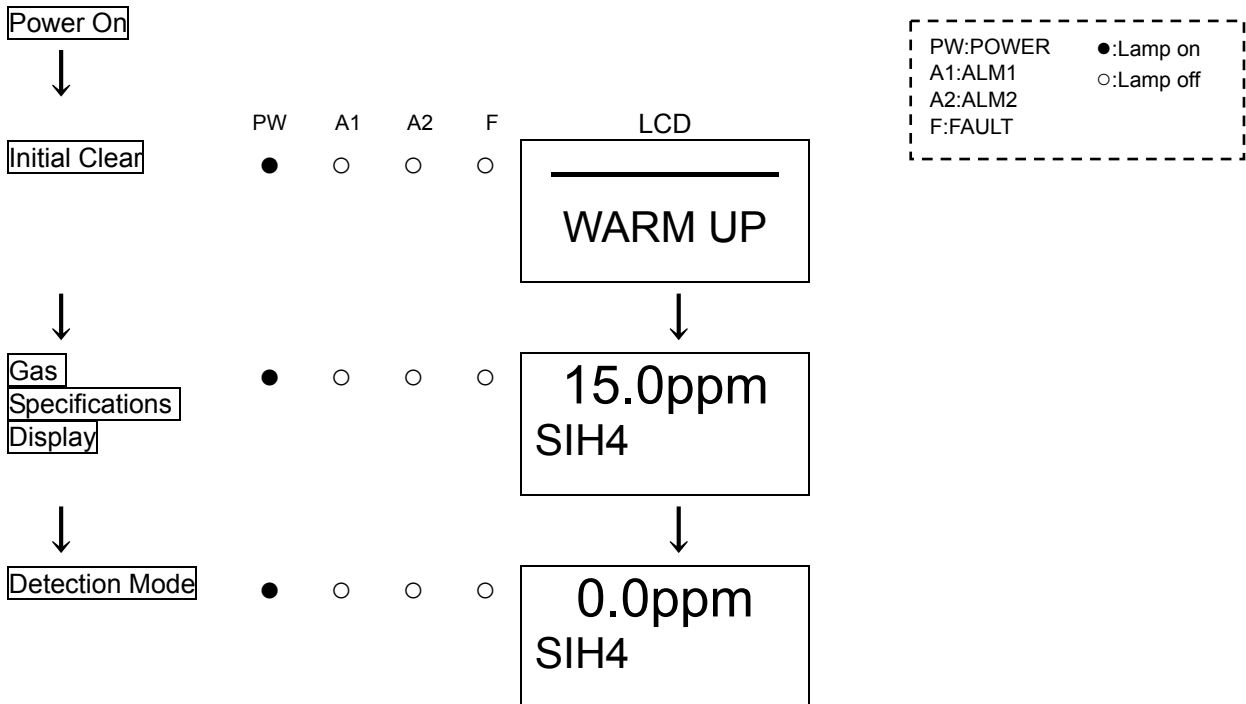

**WARNING**

- When Oxygen (OSU) is selected, approximately AIR (normal oxygen concentration) (20.9 vol%) is output after the detector is started in the atmosphere. For a specification where an alarm is triggered by the AIR (normal oxygen concentration) output (e.g., 0 - 5 vol%), be careful of an alarm issue after the detector is started.

**CAUTION**

- Do not turn off the detector during the initial clear. The detector is reading the sensor memory during the initial clear.
- If a new sensor unit is installed or the sensor unit is replaced after the detector is started, the sensor unit must be warmed up for a specified period which is determined depending on the type of the sensor unit.
When the semiconductor type sensor unit (SGU) is selected, the suggested warm-up completion time is displayed in the maintenance mode.
During the warm-up, the alarm activation and output signals are unstable. Provide a prior notification to the related sections so that they can prepare for false abnormalities.
- Because the pyrolyzer unit (PLU-70) must be warmed up for one hour, warm it up with the detector.
- After the warm-up is completed, check that the reading on the flow rate indicator corresponds to the specified flow rate, and then perform a gas calibration.

5-4. Modes

Details on each mode are provided as follows. (* Operations are slightly different depending on the detector type or sensor unit.)

Mode	Item	LCD Display	Details
Detection Mode	-	Gas concentration Gas name	Normal state
Gas Alarm Test Mode	-	Gas concentration	Perform the alarm test.
Maintenance Mode (user mode)	Zero Adjustment (Span Adjustment)	1-1 ZERO (1-1 SPAN)	Perform the zero adjustment. (In case of oxygen 0 - 25 vol%, perform the span adjustment.)
	Setting Display	1-2 CONFIRM	Show the setting of typical menus. <ul style="list-style-type: none"> • First Alarm Setpoint (AL1) • Second Alarm Setpoint (AL2) • Alarm delay time • Zero suppression value • Zero Follower ON/OFF • Sensitivity Correction ON/OFF
	Flow Rate Indicator	1-3 FLOW	Show the current flow rate.
	Address Display	1-4 ADDRESS	Show the address.
	Detector Version Display	1-5 70D VER	Show the program version of the main unit.
	Unit Version Display	1-6 UNIT VER	Show the program version of the sensor unit.
	Net Version Display	1-7 NET VER	Show the program version of the communication function.
	Regular Maintenance Mode Switching	1-8 M MODE	Switch to the regular maintenance mode.
Maintenance Mode (regular maintenance mode)	Gas Introduction Display	2-0 GAS TEST	Perform the gas introduction test in the regular maintenance mode.
	Zero Adjustment	2-1 ZERO	Perform the zero adjustment.
	Span Adjustment	2-2 SPAN	Perform the span adjustment.
	Last Calibrated Date	2-3 LAST CAL	Show the last calibrated date.
	Bias Voltage (Element Voltage)	2-4 BIAS (2-4 E VOLT)	Show the bias voltage. (Show the element voltage.)

Mode	Item	LCD Display	Details
	Flow Rate Setting (adjusted to 0.5 L/min)	2-5 DEF FLOW	Set the flow sensor with the flow rate at 0.5 L/min.
	Pump Ratio/Flow Rate Indicator	2-6 FLOW	Show the output and flow rate of the current pump.
	Detector Temperature	2-7 TEMP	Show the current temperature of the installation environment.
	Suggested Warm-up Completion Date/Time	2-8 WARMTIME	Show the suggested warm-up completion for semiconductor type (SGU).
	Environmental Setting 1	2-9 SETTING1	Operation setting <ul style="list-style-type: none"> • INHIBIT setting (INHIBIT) • Alarm value setting (ALM P) • Alarm delay time setting (ALM DLY) • Regular replacement operation (pump stop) (MAINTE) • Fault alarm test (F TEST)
	Environmental Setting 2	2-10 SETTING2	Functions setting <ul style="list-style-type: none"> • Address setting (ADDRESS) • Date/Time setting (DAY TIME) • Zero suppression value setting (SUPPRESS) • Zero suppression system setting (SUP TYPE) • Alarm test time contact setting (TEST RLY) • Alarm test time external output setting (TEST4-20) • Energized/De-energized setting (RLY PTRN) • Alarm type setting (ALM TYP) • Alarm activation setting (ALM PTRN) • Alarm value limiter setting (AL LIMIT) • Fault activation setting (FLT PTRN) • Flow rate auto-adjustment setting (AT FLOW) • Zero follower ON/OFF setting (ZERO F) • 24 hours zero follower ON/OFF setting (ZERO 24F) • Sensitivity correction ON/OFF setting (S ASSIST) • External output in maintenance mode setting (MNT OUT) • External output adjustment (MA 4-20) • Backlight setting (BK LIGHT) • ETHERNET setting (ETHERNET) • Pump drive level diagnosis ON/OFF setting (PUMP CK)
	Pyrolyzer Data Display	2-11 PL DATA	When the pyrolyzer unit (PLU-70) is used, a variety of pyrolyzer data is displayed. (See the operating manual for PLU-70)
	Fault Investigation	2-12 FAULT	Not used
	Factory Mode Switching	2-13 F MODE	Not used

5-5. Detection mode

Flow Rate Indicator

Because the suction flow rate of the detector is automatically adjusted by the flow rate control function, the flow rate, in principal, does not need to be controlled. As shown on the figure below, when the flow rate does not correspond to the specified flow rate for some reasons, it is adjusted automatically.

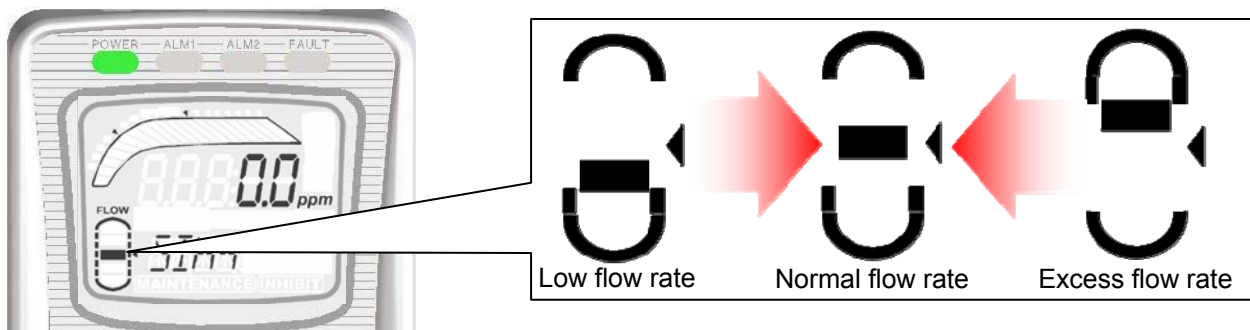

CAUTION

- If the automatic flow rate adjustment does not work (due to clogged tube or leak), messages such as "FLOW" for an unstable flow rate or "E-05" for flow rate abnormalities are displayed. In this case, you must identify the causes and take appropriate actions.

5-6. Alarm Test Mode

This is used when dummy signals the same as the signals of the gas concentration are generated to check the alarm lamp activation of the detector and the transmission to external circuits.



WARNING

- Before starting the alarm test (transmission test), provide a notification to the related sections so that they can prepare for false abnormalities (external output signals and alarm contact). After the test is completed, do not forget to press the TEST key to return to the detection mode. (If the detector remains in the alarm test mode, it automatically returns to the detection mode in ten hours.)

Alarm Test Mode

Detection Mode

Press the TEST key for three seconds.

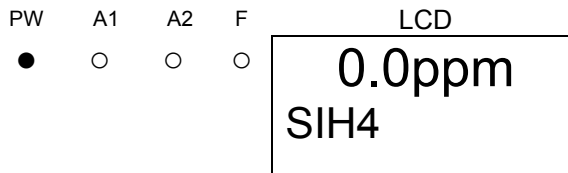

Alarm Test Mode

The message "TEST ON" is displayed when the contact is activated in the alarm test, while the message "TEST OFF" is displayed when not activated. (The setting can be changed.) Increase or decrease the reading by pressing the ▲ or ▼ key.



First Alarm

When the reading reaches the first alarm, the ALM1 lamp lights up. (When Contact ON is selected, the first alarm contact is activated.)



Second Alarm

When the reading reaches the second alarm, the ALM2 lamp lights up. (When Contact ON is selected, the second alarm contact is activated.)

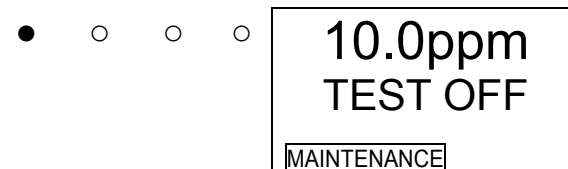

5-7. User Mode



WARNING

After the adjustment is completed, do not forget to press the MODE key to return to the detection mode. (If the detector remains in the user mode, it automatically returns to the detection mode in ten hours.)

User Mode

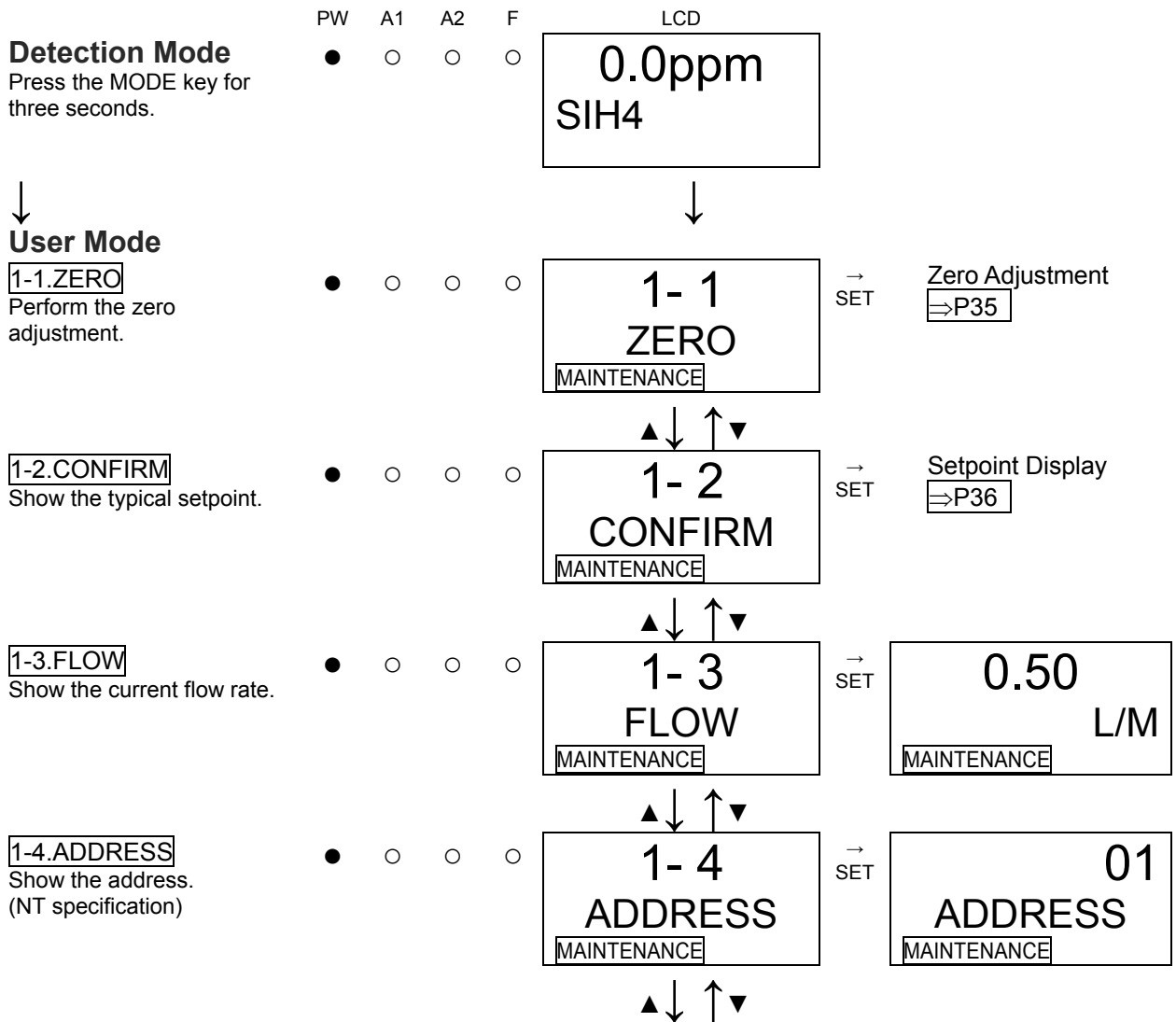

1-5.70D VER

Show the program version of the main unit.

- ○ ○ ○

1- 5
70D VER
MAINTENANCE

→
SET

01234
56AB
MAINTENANCE

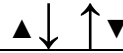

1-6.UNIT VER

Show the program version of the installed sensor unit.

- ○ ○ ○

1- 6
UNIT VER
MAINTENANCE

→
SET

01234
56AB
MAINTENANCE

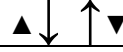

1-7.NET VER

Show the program version of the communication function.
(NT specification/ET specification)

- ○ ○ ○

1- 7
NET VER
MAINTENANCE

→
SET

01234

MAINTENANCE

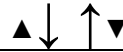

1-8.M MODE

Switch to the regular maintenance mode.

- ○ ○ ○

1- 8
M MODE
MAINTENANCE

→
SET

See "7. Regular Maintenance Mode".

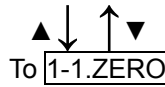

<Zero Adjustment "1-1">

This is used to perform the zero adjustment. Before starting the zero adjustment, let the detector draw the zero adjustment gas and wait until the indicator is stabilized.

For oxygen deficiency alarm specification (OSU - 0 to 25 vol%), "1-1" is the span adjustment. In this case, the AIR adjustment is performed, so that fresh air must be introduced to adjust it to 20.9 vol%. For information on the span adjustment, see "7-2. How to perform a gas calibration".

Zero Adjustment

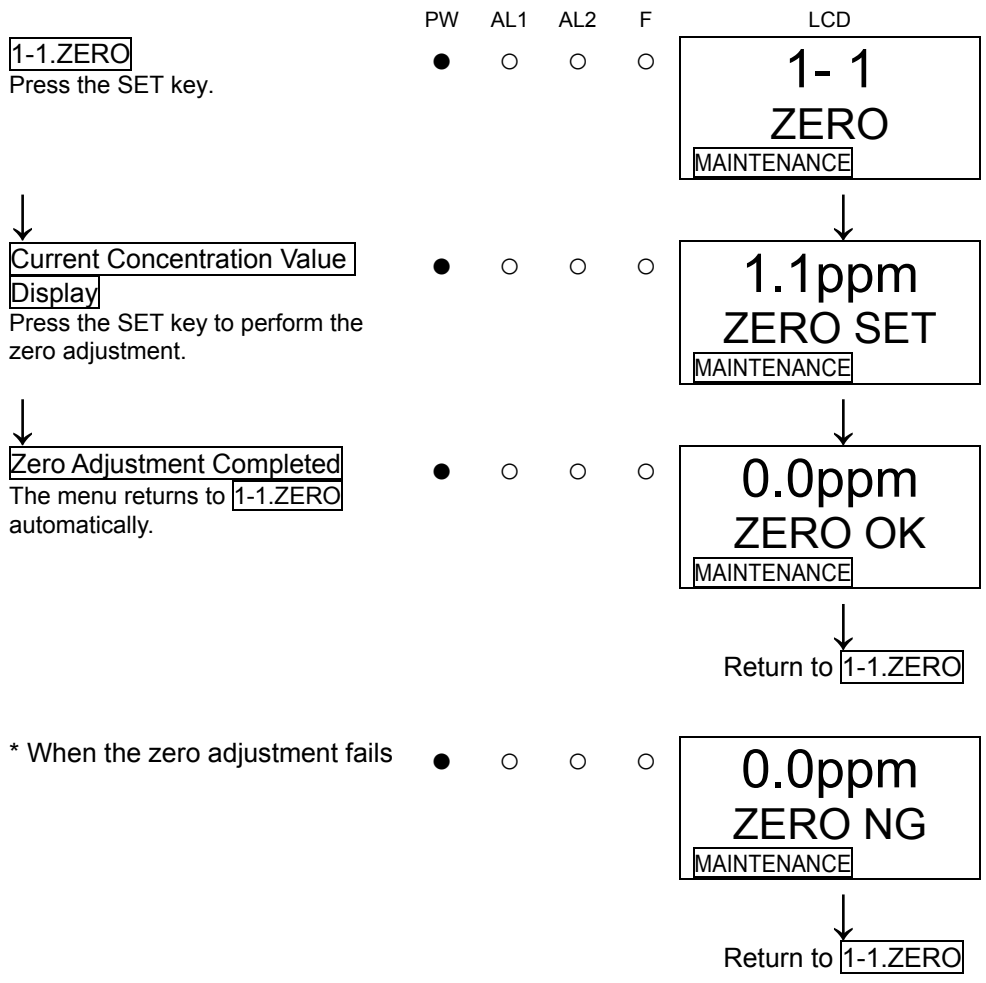

<Setting Display "1-2">

This is used to check the setting of typical menus.

Setting Display

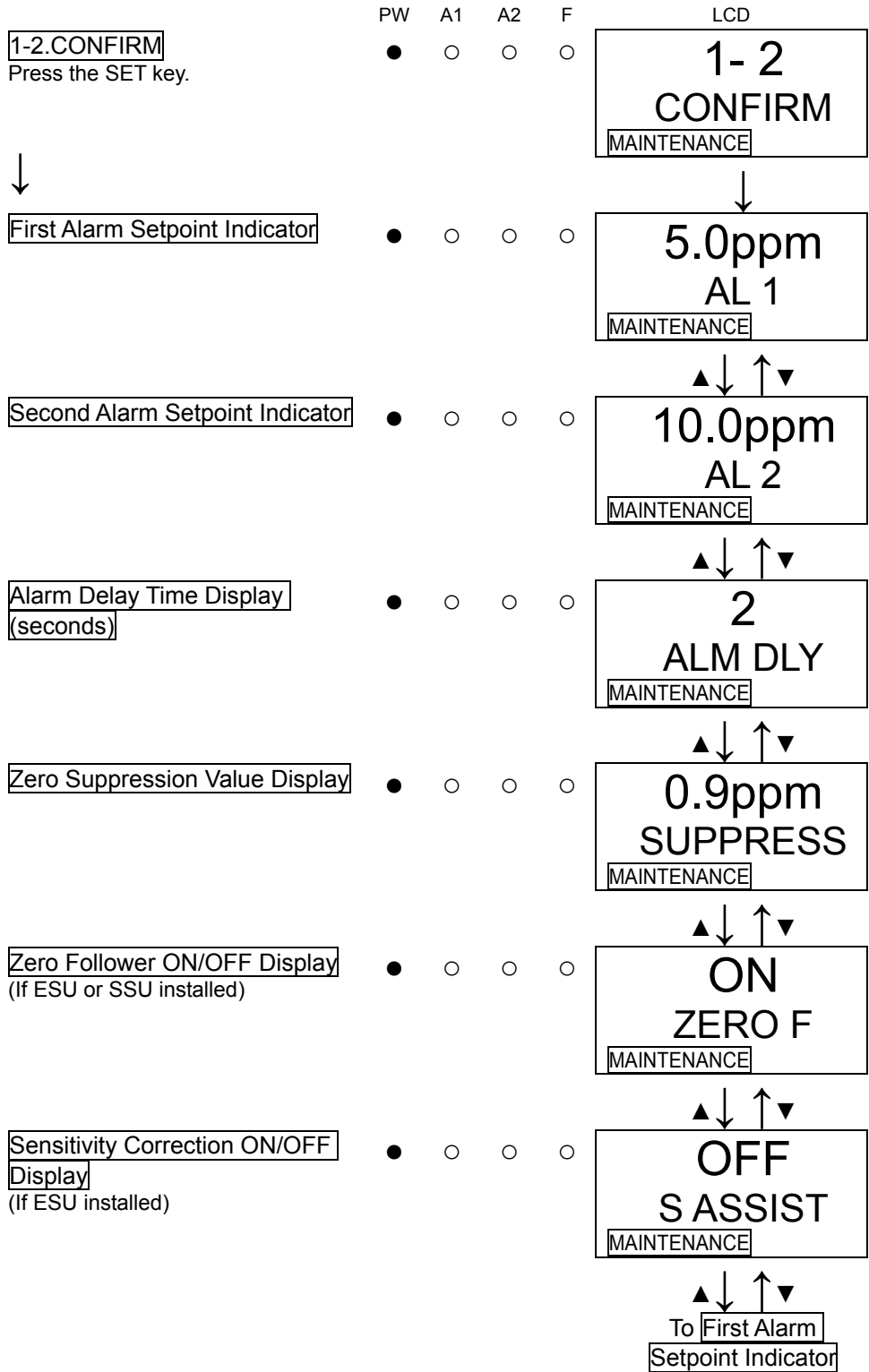

5-8. How to exit

To turn off the detector, open the switch cover on the bottom of the main unit, and turn "OFF" the power switch. Then, turn off the power supply (24 VDC) to the detector.



WARNING

- When the detector is turned off, an alarm may be activated on the upper (central) system. Before turning off the detector, the inhibit (point skip) on the upper (central) system must be activated. Decide whether the power can be turned off by checking the operation of the devices connected to the external output or external contact output terminal of the detector.
- If the alarm contact is energized (option), it is activated when the detector is turned "OFF".
- If the gas to be detected has an adsorptive property, the detector must be cleaned thoroughly with fresh air before turning "OFF" the detector.

6

Detection Mode

6-1. Gas alarm activation

Gas alarm: Activated when the concentration of detected gas reaches or exceeds the alarm setpoint value.
<<Auto-Reset Operation>>

NOTE

The alarm setpoint (first alarm and second alarm) is factory-set. Although the alarm delay time (standard: 2 seconds) works in the detector to prevent a false activation, it can be cancelled if not needed.

<Display Operation>

Gas Concentration Display

In case of over the detection range (Over Scale), "□□□□" is displayed on the LCD.

Power Indicator Lamp (POWER: Green)

This lights up continuously.

Alarm Indicator Lamp (ALM1: Red), (ALM2: Red)

The alarm consists of two steps. Each of them lights up when the respective alarm setpoint value is reached to or exceeded.

<Contact Activation>

The contact is activated when the gas concentration reaches or exceeds the alarm setpoint value. The contact activation is reset automatically when the gas concentration drops below the alarm setpoint value.

'Alarm Pattern (H-HH)'

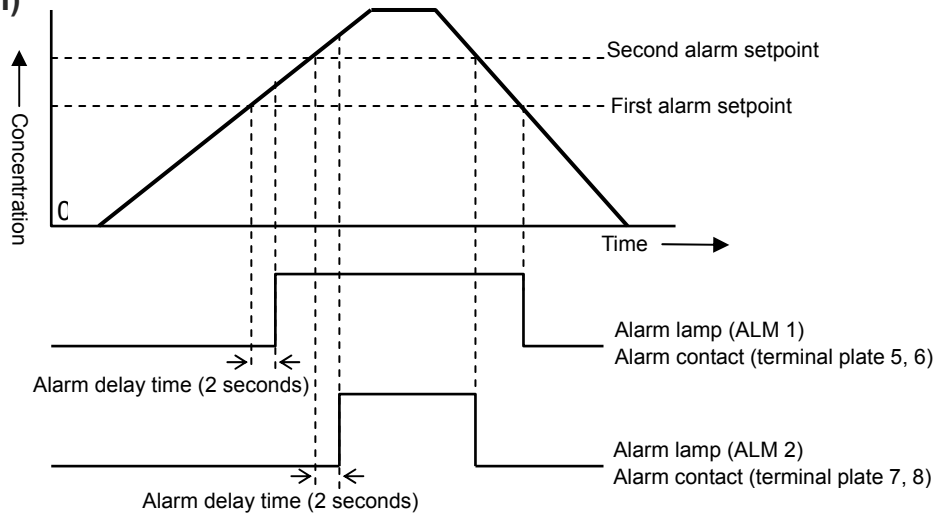

'Alarm Pattern (L-LL)' (* oxygen deficiency alarm)

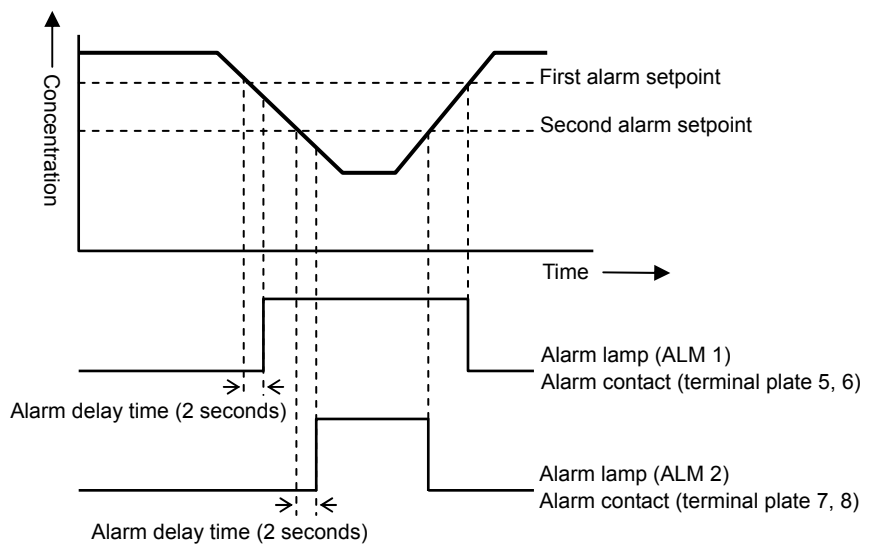

<Response to Gas Alarm>

In case of responding to a leaked gas

When a gas alarm is triggered, take actions in accordance with your management rules of gas alarm. Normally, take the following actions.

- Check the reading of the detector.

NOTE

If a gas leak is momentary, the reading may already have dropped when you check it. In addition, when the alarm is triggered by noise or other incidental conditions other than a gas, the reading may have already dropped.

- Based on your management rules of gas alarm, no one can be allowed to access the monitored zone to ensure safety.
- If the Gas Concentration Display continues to be shown, close the main valve of the gas, and then check that the gas concentration reading dropped.
- Equipped with a protective gear to avoid dangers caused by possibly remaining gases, before accessing the gas leak point, and then check whether gases remain by using a portable gas detector.
- If you can determine that the point is free from dangers, take actions to fix the gas leak.

6-2. Fault alarm activation

A fault alarm is triggered when the detector detects abnormalities. After a fault alarm is triggered, the FAULT lamp (yellow) lights up and an error message is displayed on the LCD. Determine the causes and take appropriate actions.

After the detector is successfully returned from the fault, it restarts with the process normally performed right after it is turned on (initial clear).

If the detector has problems and is repeatedly malfunctioning, contact us immediately.



* E-5 FLOW (flow rate abnormalities)

NOTE

For information on malfunctions (error messages), see "9. Troubleshooting".

6-3. External output operation

Specifications	4 - 20 mA	Power-line communication system (NT)	Ethernet (ET)
Signal Transmission System	Analog transmission (non-isolated)	2-wire type DC power-line communication	Ethernet (10BASE-T/100BASE-TX)
Transmission Path	CVVS	KPEV-S	Ethernet cable
Transmission Distance	Below 1 km	Below 300 m (depending on the system conditions)	Below 100 m (depending on the system conditions)
Connection Load Resistance	Below 300 Ω	-	
(1) Detection Mode (No Alarm)	4 - 20 mA (concentration output)	Concentration data	
(2) Detection Mode (Gas Alarm)	4 - 20 mA (concentration output)	Concentration data, Alarm bits	
(3) Initial Clear	<u>Depending on the setting of (4)</u> 2.5 mA setting: 2.5 mA 4 mA, HOLD, 4 - 20 mA setting: 4 mA*	Initial bit	
(4) Maintenance Mode	2.5 mA setting: 2.5 mA 4 mA setting: 4mA* HOLD Setting: the previous value retained 4-20 mA setting: 4 - 20 mA (concentration output)	Concentration data, Adjustment bit	
(5) Alarm Test	Output ON setting: 4 - 20 mA (concentration output) Output OFF setting: the previous value retained	Concentration data, Adjustment bit, Test bit	
(6) Fault Alarm	0.5 mA (Fixed)	Fault bits	
(7) Inhibit	<u>Depending on the setting of (4)</u> 2.5 mA setting: 2.5 mA 4 mA, HOLD, 4 - 20 mA setting: 4 mA*	Concentration data, Adjustment bit, Inhibit bit	
(8) Power Off	0 mA	Signal OFF	

* OSU - 0 - 25 vol% is equivalent of AIR (20.9 vol% = 17.4 mA)

Example of Gas Concentration and External Output

4 - 20 mA Specification
(Maintenance output: 2.5 mA setting)

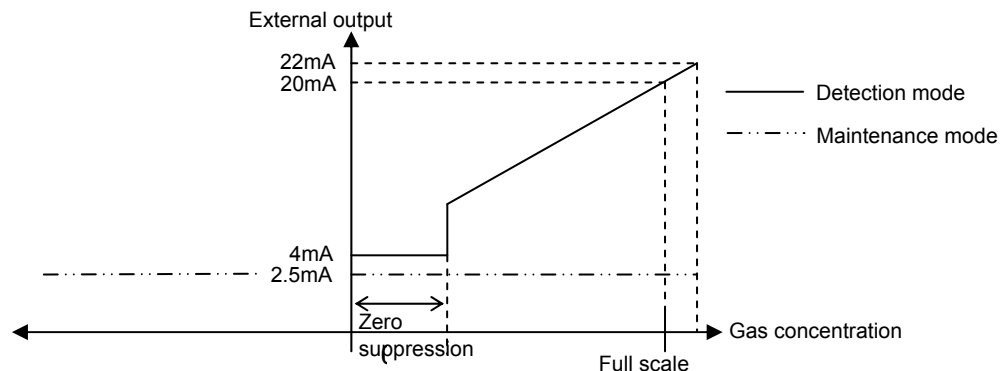

CAUTION

<<4 - 20 mA Specification>>

- The 4 - 20 mA output is already adjusted. In case of over scale, an output will not exceed 22 mA.
- Output during inhibit or initial clear is based on 4 - 20 mA output setting in the maintenance mode. Be careful for a possible lower output which drops as low as 2.5 mA during initial clear when OSU (L alarm) is used. In particular, this occurs when the detector is started or the specification is changed. Understand how the detector functions, and take actions, if necessary, so that the receiver side can not get false alarms (e.g. making a inhibit status).

<Example of Items which Requires Special Precautions>

Maintenance output setting	Sensor unit	Details
2.5 mA	Use OSU (L-LL, L-H).	Output 2.5 mA during maintenance or inhibit. Possibility of false alarm in the upper unit (L alarm)
4 mA, HOLD, 4 - 20 mA	Specification change (To OSU - 0 - 25 vol%)	In case of a change from another principle (H-HH), 4 mA (equivalent of concentration zero) is used until the change is confirmed "C-02".
	Specification change (From OSU - 0 - 25 vol%)	In case of a change from 0 - 25 vol% (L-LL,L-H), 17.4 mA (equivalent of approx. 84%FS) is used until the change is confirmed "C-02".

<Communication Specifications>

GD-70D-NT	Power-line communication system	The detector is used in a local network formed with a multi-display unit (RM-70NT) as the base unit. For more information, see the operating manual of the multi-display unit.
GD-70D-ET	Ethernet	<p>The detector offers functions that work in liaison with external software using a standard network protocol. For more information, please contact our sales department.</p> <p>Web function (HTTP), mail send function (SMTP), and time synchronization function (SNTP) Use a Web browser of an upper-unit PC to view and change setting values and perform calibration and test on a graphical user interface. SMTP, when receiving a gas alarm or fault alarm from an external mail server, can send a notification mail to a registered address. SNTP, receiving time information from a time server, can correct the clock at regular intervals.</p> <p>Modbus slave function (Modbus/TCP) The detector, working as a Modbus slave, feeds back a setting value in response to a read request or changes a setting value in response to a write request.</p> <p>PLC linkage function (FINS•MC) The detector sends a setting value to PLC to provide information to be processed by PLC in a ladder program. Reading from PLC is also available to change a setting value or perform calibration and test.</p>

6-4. Other functions

<Suppression Function>

Some types of sensor used with the detector are influenced by environmental changes (temperature, humidity, and other characteristics) or interference gases (interference characteristics) in no small measure, which affects the reading.

Therefore, the reading might vary around zero even in a normal environment with no gas leakage.

This function obscures influences by environmental changes and interference gases around zero that have no meaning for your management rules of gas alarm. This function is used to hide (suppress) the variation of the reading under the setting value, indicating zero.

<<Example: SiH4 0 - 15 ppm rated range>>

0.5ppm
SiH4

Suppression Disabled

A variation around zero is displayed as the reading.



0.0ppm
SiH4

Suppression Enabled

A variation under the standard setting value = 6% FS (0.9 ppm) is hidden with zero. (Zero suppression)

NOTE

In the maintenance mode, this function is disabled and the variation of the reading under the setting value is displayed.

When a sensor unit with the oxygen deficiency alarm (OSU 0 - 25 vol%) is equipped, the zero suppression is shifted to AIR suppression automatically. That is, a small variation of the reading around 20.9 vol% is displayed as 20.9 vol%.



CAUTION

- A reading under zero is suppressed with the 10% FS suppression.
- A reading that is 10% FS or more under zero is displayed as "-0.0", which prevents an accurate gas detection and needs the zero adjustment.

<Zero Follower Function>

Some types of sensor used with the detector might have sensitivity variations after being used for a long period.

This function corrects the variation of the reading at the zero point (zero drift) among the sensitivity variations over time by a program manipulation to stabilize the zero point, and works on the electrochemical type (ESU) and pyrolysis-particle type (SSU).

Zero Follower Off

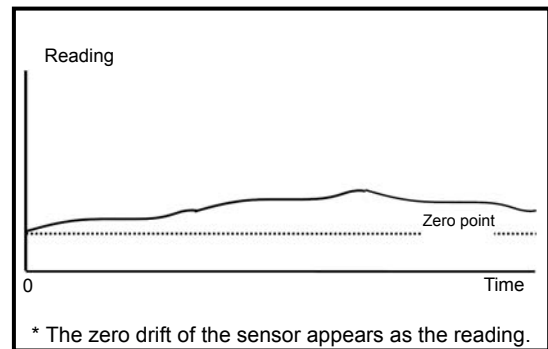

Zero Follower On

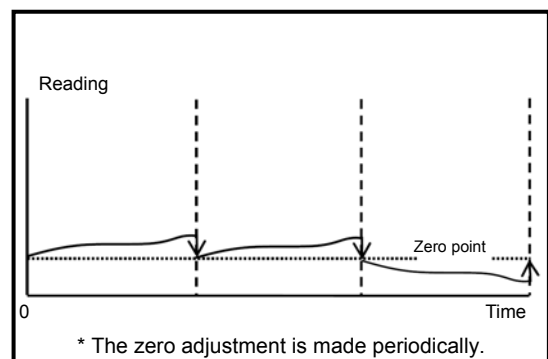

<Sensitivity Correction Function>

Some types of sensor used with the detector might have sensitivity variations after being used for a long period.

This function compensates the degradation of the gas sensitivity among the sensitivity variations over time. It works on the electrochemical type (ESU) and makes the span adjustment by a program manipulation based on the principled degradation pattern.

Sensitivity Correction Off

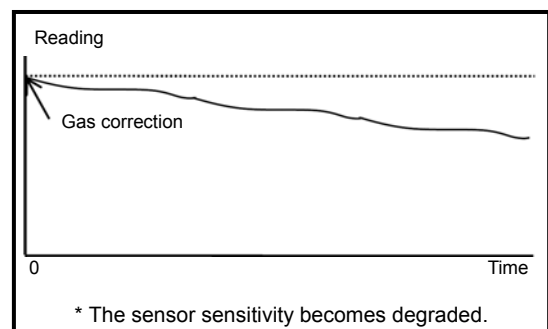

Sensitivity Correction On

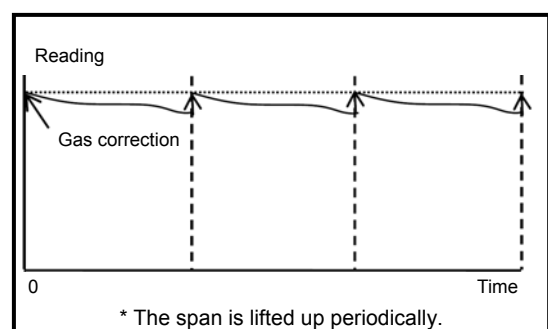



CAUTION

The sensitivity correction is just an auxiliary function. It uniformly lifts the span up based on the principled degradation pattern only and cannot consider the sensitivity variation of an individual sensor. To correct the sensitivity variation of an individual sensor, you must make the regular span adjustment using calibration gas.

<Calibration History/Alarm Trend History/Event History Functions>

The detector and the sensor unit have their own history functions. To use these functions, contact our sales department.

<Sensor Unit Automatic Recognition Function>

The detector has the function to automatically recognize the sensor unit when the sensor unit is replaced or the specification is changed.

When a sensor unit with a different serial number or with a different principle or specification is attached, one of the following messages is displayed for helping the correct installation.

C-01
CHG UNIT

MAINTENANCE

Unit Replacement

Displayed when a unit with the same specification (principle, type, and so on) is attached (e.g. in a regular replacement).

Press the MODE key to recognize the new sensor unit and start the monitor.

CHG UNIT ⇔ USED SEN

is displayed if the unit that you installed has the same or earlier date of manufacture than the one that has been replaced. Check for correct installation if this message is displayed because an old sensor might have been installed by mistake.

↓
C-02
CHG SPEC

MAINTENANCE

Specification Change

Displayed when a unit with a different specification (principle, type, and so on) from the previous one is attached.

Press the MODE key to recognize the unit with the new specification and start the monitor.

If you do not intend the specification change, this message might mean the installation error. Check the correct installation.



CAUTION

If you confirm the specification change (principle, sensor type, detected gases, detectable range, and so on) of the sensor unit for "C-02", the specification of the gas detector head is changed. Note that it resets the alarm setpoint (ALM P) as well as the following parameters to the standard setting values.

If you want to use nonstandard setting values, set them in the maintenance mode.

- Alarm delay time setting (ALM DLY)
- Suppression value (SUPPRESS)
- Alarm type (ALM TYP) The OSU specification includes "L-LL", "L-H", and "H-HH".

<Standard Setting Values by Principle>

	ESU	SSU	NCU	SGU	OSU (0 - 25 vol%)	OSU (0 - 5 vol%)	OSU (0 - 50 vol%)
Alarm delay	2 seconds	2 seconds	2 seconds	2 seconds	2 seconds	2 seconds	2 seconds
Suppression value	6%FS	2 ppm (TEOS)	6%FS (0 - 100%LEL)	10%FS	0.5 vol% (AIR supp)	0 vol%	0 vol%
Alarm type	H-HH	H-HH	H-HH	H-HH	L-LL	H-HH	H-HH

"Change from OSU (L-LL alarm)" or "change to OSU (L-LL alarm)" reverses the direction of the alarm. It requires special care because the previous settings are kept for the external output and other settings in the maintenance mode. Immediately after "C-02" is confirmed with the MODE key, the initial clear is started and the new actions are enabled. (The initial clear output is shifted together.)

7

Maintenance

This is an important instrument for the purpose of safety. To maintain the performance of the detector and improve the reliability of safety, perform a regular maintenance.

NOTE

To use the pyrolyzer unit (PLU-70), also refer to the separate operating manual.

7-1. Maintenance intervals and items

- Daily maintenance: perform a maintenance before beginning to work.
- Monthly maintenance: perform a maintenance on the alarm circuit (alarm test) once a month.
- Regular maintenance: perform a maintenance once or more for every six months to maintain the performance as a safety unit.

Maintenance item	Maintenance content	Daily maintenance	Monthly maintenance	Regular maintenance
Power supply check	Check that the power lamp lights up.	○	○	○
Concentration display check	Check that the concentration display value is zero (or 20.9 vol% on the oxygen deficiency meter). When the reading is incorrect, perform the zero adjustment after ensuring that no other gases exist around it.	○	○	○
Flow rate check	See the flow rate indicator to check for abnormalities.	○	○	○
Filter check	Check the dust filter for dust or clogging.	○	○	○
Alarm test	Inspect the alarm circuit by using the alarm test function.		○	○
Span adjustment	Perform the sensitivity calibration by using the calibration gas.			○
Gas alarm check	Check the gas alarm by using the calibration gas.			○

<About Maintenance Services>

- We provide services on regular maintenance including span adjustment, adjustment and maintenance. To make the calibration gas, dedicated tools, such as a gas cylinder of the specified concentration and gas sampling bag must be used. Our qualified service engineers have expertise and knowledge on the dedicated tools used for services, along with other products. To maintain the safety operation of the detector, please use our maintenance service.
- The followings are typical maintenance services. Please contact our sales department for more information.

Main Services

Power Supply Check	:	Checks the power supply voltage. Verifies that the power lamp lights up. (Verifies that relevant points can be identified on the system.) (When a UPS (uninterruptible power system) is used, checks the operation with the UPS (uninterruptible power system).)
Concentration Display Check	:	Verifies that the concentration display value is zero (or 20.9 vol% on the oxygen deficiency meter) by using the zero gas. Performs the zero adjustment (AIR adjustment) if the reading is incorrect.
Flow Rate Check	:	Checks the flow rate indicator to find abnormalities. Checks the flow rate by using an external flow meter to verify the correctness of the flow rate indicator on the detector. If the flow rate is incorrect, performs the flow rate adjustment.
Filter Check	:	Checks the dust filter for dust or clogging. Replaces a dirty or clogged dust filter.
Alarm Test	:	Inspects the alarm circuit by using the alarm test function. <ul style="list-style-type: none"> • Checks the alarm lamps. (Checks each activation of ALM1 and ALM2.) • Checks the external alarm. (Checks the activation of the external alarm, such as a buzzer.)
Span adjustment	:	Performs the sensitivity calibration by using the calibration gas.
Gas Alarm Check	:	Checks the gas alarm by using the calibration gas. <ul style="list-style-type: none"> • Checks the alarm. (Checks the alarm activation when the alarm setpoint is reached.) • Checks the delay time. (Checks time to delay until the alarm is triggered.) • Check the alarm lamps. (Check each activation of ALM1 and ALM2.) • Check the external alarm. (Check the activation of external alarms, such as a buzzer and reset signal.)
Cleaning and repair of the detector (visual diagnosis)	:	If you find dust or damage on surface, cover, or internal parts of the detector, clean and repair such parts of the detector. Replace parts which are cracked or damaged.
Detector Operation Check	:	Uses the keys to check the operation of functions and parameters.
Replacement of Consumable Parts	:	Replaces consumable parts, such as a sensor, filter and pump.

7-2. Regular Maintenance Mode



WARNING

After the adjustment is completed, do not forget to press the MODE key to return to the detection mode. (If the detector remains in the maintenance mode, it automatically returns to the detection mode in ten hours.)

Mode	Item	LCD Display	Details
Maintenance Mode (regular maintenance mode)	Gas Introduction Display	2-0 GAS TEST	Perform the gas introduction test in the regular maintenance mode.
	Zero Adjustment ⇒P65	2-1 ZERO	Perform the zero adjustment.
	Span Adjustment ⇒P67	2-2 SPAN	Perform the span adjustment.
	Last Calibrated Date	2-3 LAST CAL	Show the last calibrated date.
	Bias Voltage (Element Voltage)	2-4 BIAS (2-4 E VOLT)	Show the bias voltage. (Show the element voltage.)
	Flow Rate Setting (adjusted to 0.5 L/min) ⇒P68	2-5 DEF FLOW	Set the flow sensor with the flow rate at 0.5 L/min.
	Pump Ratio/Flow Rate Indicator ⇒P68	2-6 FLOW	Show the output and flow rate of the current pump.
	Detector Temperature	2-7 TEMP	Show the current temperature of the installation environment.
	Suggested Warm-up Completion Date/Time	2-8 WARMTIME	Show the suggested warm-up completion for semiconductor type (SGU).
	Environmental Setting 1 ⇒P54	2-9 SETTING1	Operation setting <ul style="list-style-type: none"> • INHIBIT setting (INHIBIT) • Alarm value setting (ALM P) ⇒P55 • Alarm delay time setting (ALM DLY) • Regular replacement operation (pump stop) (MAINTE) • Fault alarm test (F TEST) ⇒P55

Mode	Item	LCD Display	Details
	Environmental Setting 2 ⇒P56	2-10 SETTING2	Functions setting <ul style="list-style-type: none"> • Address setting (ADDRESS) • Date/Time setting (DAY TIME) ⇒P61 • Zero suppression value setting (SUPPRESS) • Zero suppression system setting (SUP TYPE) • Alarm test time contact setting (TEST RLY) • Alarm test time external output setting (TEST4-20) • Energized/De-energized setting (RLY PTRN) ⇒P62 • Alarm type setting (ALM TYP) • Alarm activation setting (ALM PTRN) • Alarm value limiter setting (AL LIMIT) • Fault activation setting (FLT PTRN) • Flow rate auto-adjustment setting (AT FLOW) • Zero follower ON/OFF setting (ZERO F) • 24 hours zero follower ON/OFF setting (ZERO 24F) • Sensitivity correction ON/OFF setting (S ASSIST) • External output in maintenance mode setting (MNT OUT) • External output adjustment (MA 4-20) • Backlight setting (BK LIGHT) • ETHERNET setting (ETHERNET) ⇒P63 • Pump drive level diagnosis ON/OFF setting (PUMP CK)
	Pyrolyzer Data Display	2-11 PL DATA	When the pyrolyzer unit (PLU-70) is used, a variety of pyrolyzer data is displayed. (See the operating manual for PLU-70)
	Fault Investigation	2-12 FAULT	Not used
	Factory Mode Switching	2-13 F MODE	Not used

Regular Maintenance Mode

PW: POWER ●: Lamp on
 A1: ALM1 ○: Lamp off
 A2: ALM2
 F: FAULT

User Mode

In "1-8.M MODE", press the SET key.

PW A1 A2 F

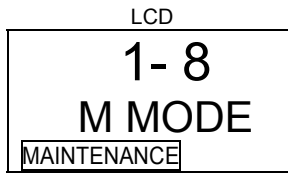

↓
Then press the SET key again for three seconds.

● ○ ○ ○

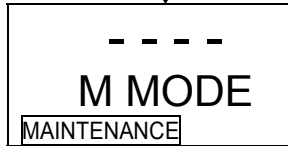

↓
Regular Maintenance Mode

2-0.GAS TEST

Perform a test with the gas. Similar to the detection mode, the reading changes and the alarm lamp lights up after the gas is introduced, but the contact is not activated.

● ○ ○ ○



→ SET

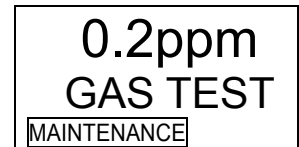

↓ (Alternate Display) ↑

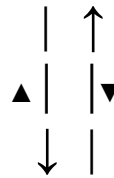
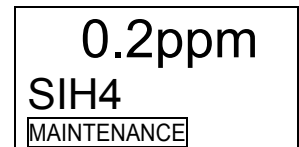

2-1.ZERO

Perform the zero adjustment.

● ○ ○ ○

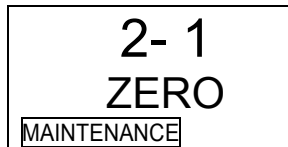

→ SET

Zero Adjustment
⇒ P65

2-2.SPAN

Perform the span adjustment.

● ○ ○ ○



→ SET

Span Adjustment
⇒ P67

2-3.LAST CAL

Show the last calibrated date.

● ○ ○ ○

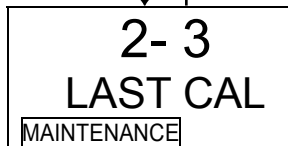

→ SET

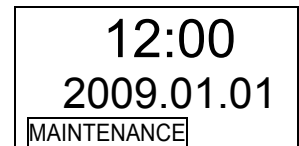

2-4.BIAS

Show the bias voltage "BIAS" of electrochemical type (ESU) or the element voltage "EVOLT" of semiconductor type (SGU).

● ○ ○ ○

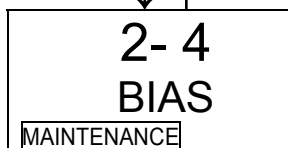

→ SET



2-5.DEF FLOW

Set the flow rate to the default value when the flow sensor is replaced, etc. Normally, this is not used because the detector has already been adjusted. On the other hand, if the flow meter is set at other than the specified flow rate, gases cannot be detected properly due to an incorrect flow rate. (Press the MODE key to cancel this menu.)

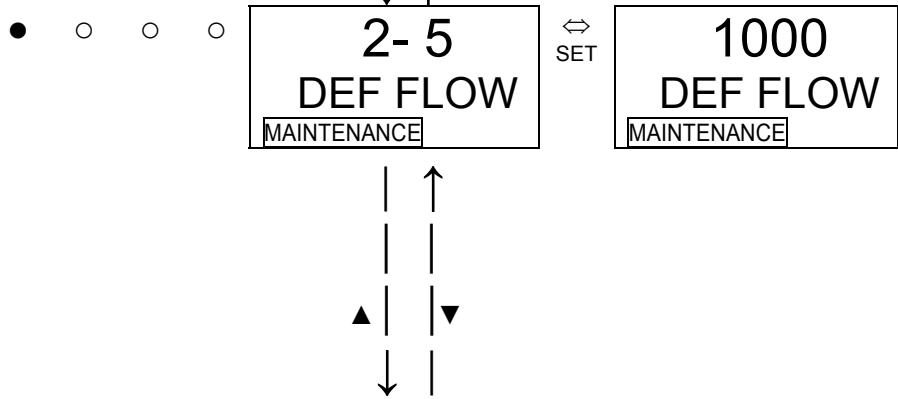

2-6.FLOW

Show the output and flow rate of the current pump.

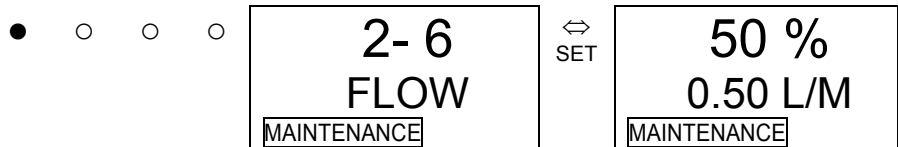

2-7.TEMP

Show the temperature of the detector.



2-8. WARMTIME

Show the suggested warm-up completion date/time for semiconductor type (SGU), which requires a long warm-up time.



2-9. SETTING1

Specify the environmental setting 1.

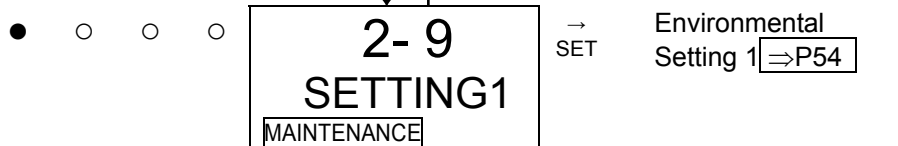

2-10.SETTING2

Specify the environmental setting 2.

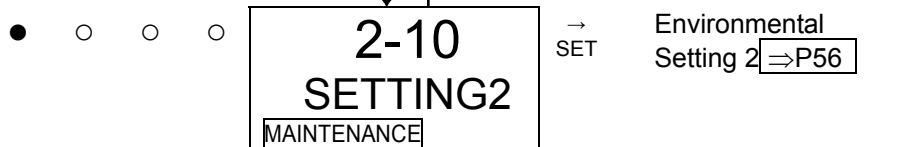

2-11.PL DATA

Show the pyrolyzer data when the pyrolyzer unit (PLU-70) is used.

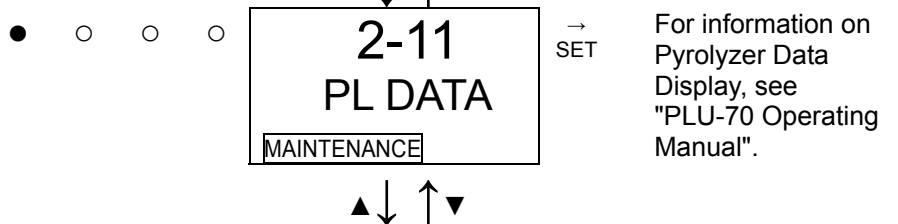

2-12.FAULT

This is used (by the manufacturer) to investigate and analyze the causes of faults. This is not used by the user.

- ○ ○ ○

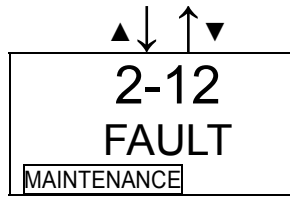

2-13.F MODE

Changes to the factory mode. This is not used by the user.

- ○ ○ ○

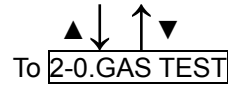
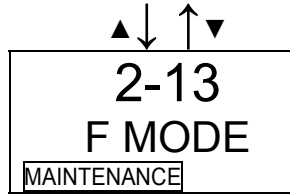

<Environmental Setting 1 "2-9">

In the environmental setting 1, specify the operation setting.

Environmental Setting 1

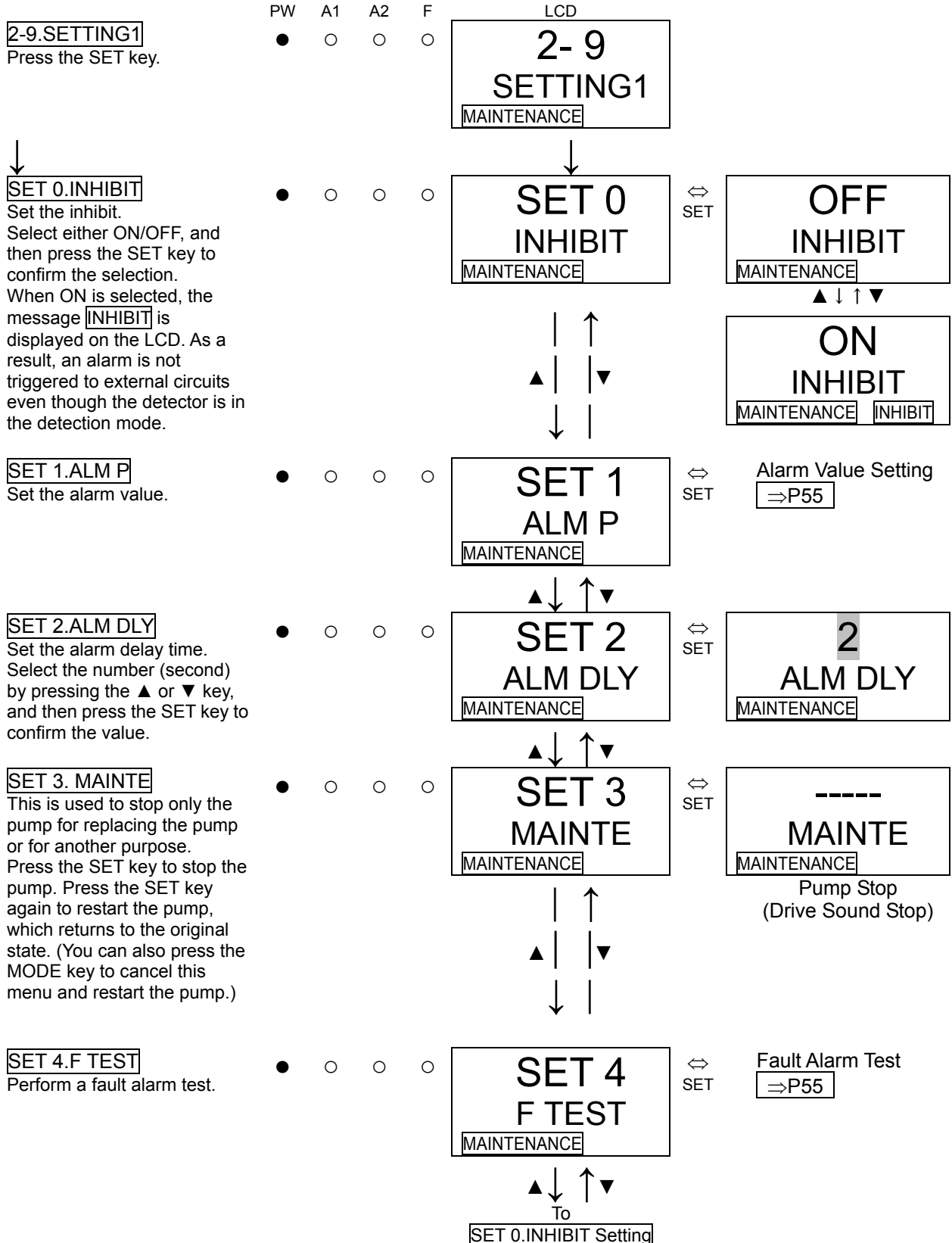

<Alarm Value Setting "2-9" - "SET 1">

Alarm Value Setting

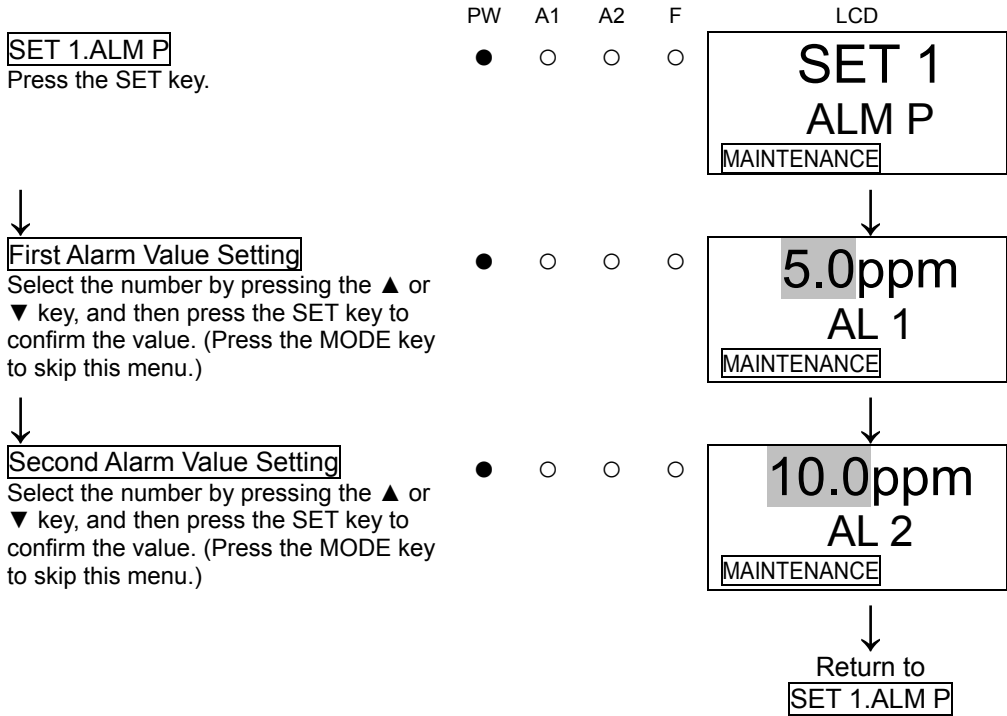

<Fault Alarm Test "2-9" - "SET 4">

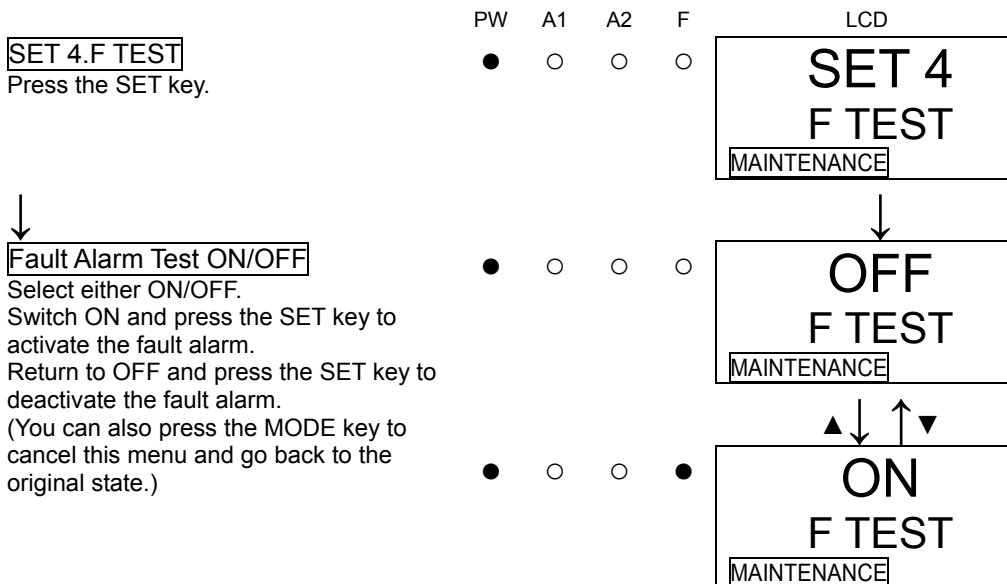

WARNING

Because the contact (fault) can be activated only by a fault alarm test in the maintenance mode, be careful to perform the test. The fault alarm test cannot be performed during inhibit.

<Environmental Setting 2 "2-10">

In the environmental setting 2, specify the settings of functions. (* It is recommended that setting changes should be recorded in a log.)

The environmental setting 2 includes setting menus which are usually not used. Be careful not to change these settings by mistake.

Environmental Setting 2

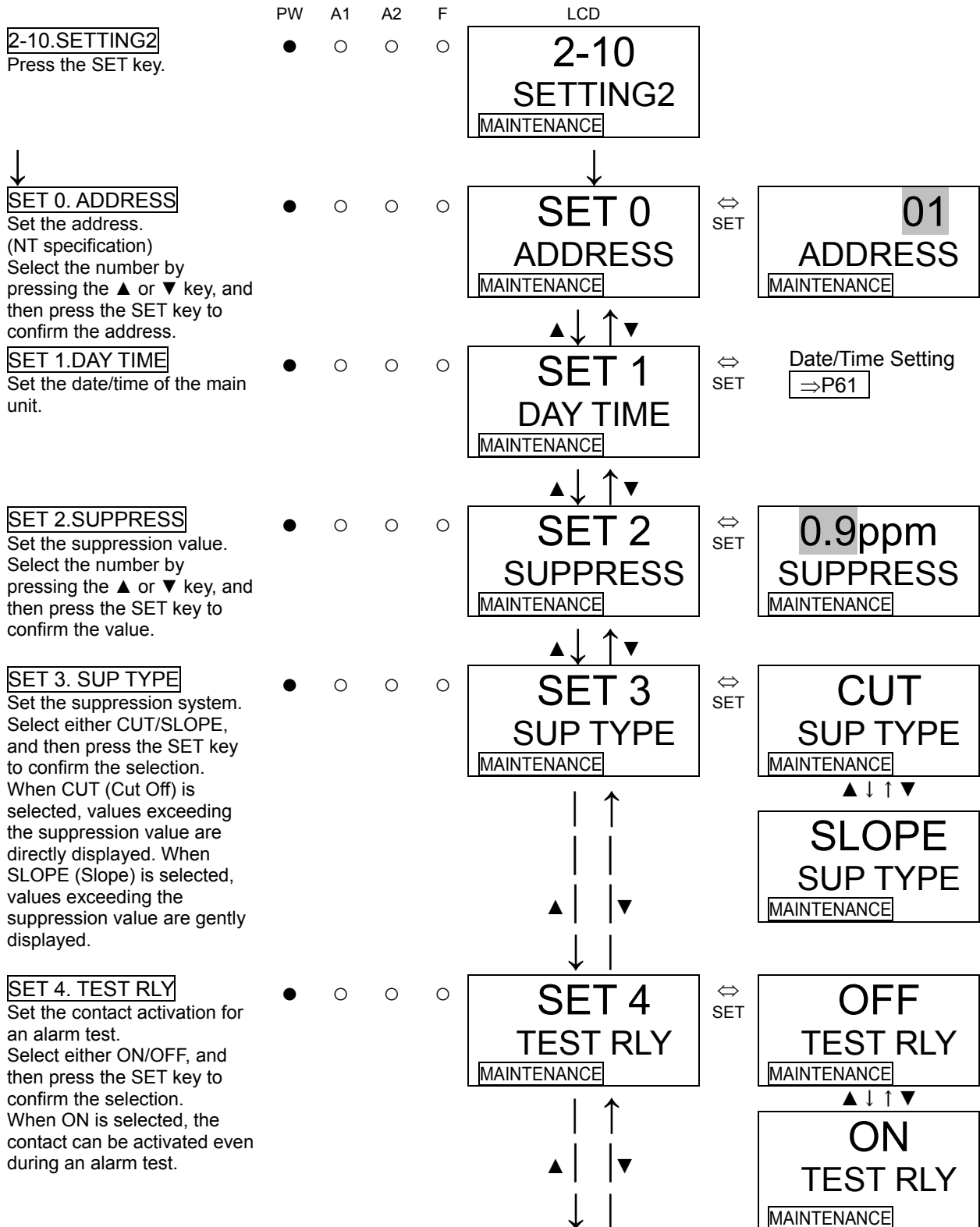

SET 5.TEST4-20

Set the external output for an alarm test.
 Select either ON/OFF, and then press the SET key to confirm the selection.
 When ON is selected, the external output (4 - 20 mA) is output even during an alarm test.
 When OFF is selected, the output is kept at the one just before the alarm test mode is entered (HOLD).

-
-
-
-

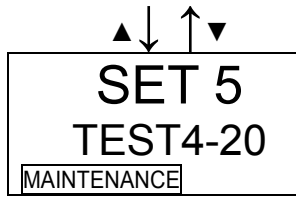

⇔ SET

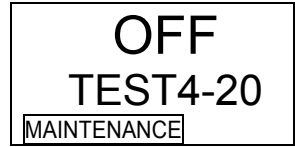
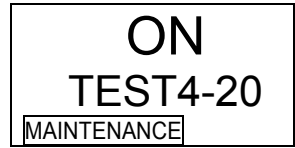

SET 6.RLY PTRN

Select either energized/de-energized for the contact.

-
-
-
-

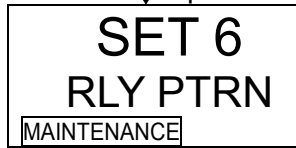

⇔ SET

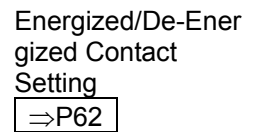

SET 7.ALM TYPE

Set the alarm type.
 When the galvanic cell type (OSU) is installed, you can select either L-LL, L-H, or H-HH.

-
-
-
-

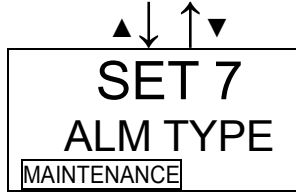

⇔ SET

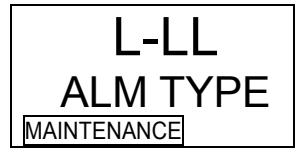

SET 8.ALM PTRN

This is a setting screen of the gas alarm activation. Do not change the setting when the detector is used in a normal way, because it determines how the detector functions. (Auto-reset setting: "nL")

-
-
-
-

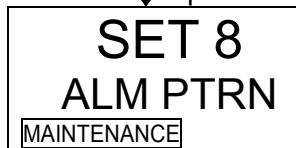

SET 9.AL LIMIT

This is a setting screen of the alarm value limiter. Do not change the setting when the detector is used in a normal way. (ON setting)

-
-
-
-



SET 10. FLT PTRN

This is a setting screen of the fault alarm activation. Do not change the setting when the detector is used in a normal way, because it determines how the detector functions. (Auto-reset setting: "nL")

- ○ ○ ○

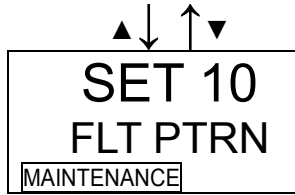

SET 11. AT FLOW

Set the flow rate auto-adjustment. Select either ON/OFF, and then press the SET key to confirm the selection. When ON is selected, the flow rate auto-adjustment is activated.

- ○ ○ ○

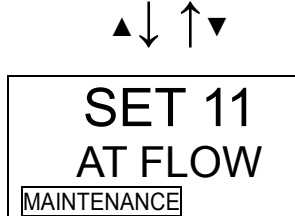

SET 12. ZERO F

Set the zero follower when the electrochemical type (ESU) or the pyrolysis-particle type (SSU) is installed. Select either ON/OFF, and then press the SET key to confirm the selection. When ON is selected, the zero follower function is activated.

* When SSU is installed, you must select ON.

- ○ ○ ○

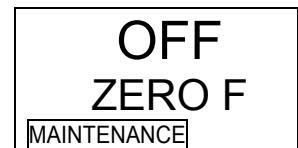

SET 13. ZERO 24F

This is a supplemental setting screen for the above zero follower function. (A setting to determine whether the first-24-hour zero follower will be performed after the power is turned on.) Do not change the setting when the detector is used in a normal way. (ON setting)

- ○ ○ ○



SET 14. S ASSIST

Set the sensitivity correction when the electrochemical type (ESU) is installed. Select either ON/OFF, and then press the SET key to confirm the selection. When ON is selected, the sensitivity correction function is activated.

- ○ ○ ○



SET 15. MNT OUT

Set the external output for the maintenance mode.
 Select either 2.5 mA/4.0 mA/HOLD (previous value)/4 - 20 mA (linked to display value), and then press the SET key to confirm the selection.
 (4 - 20 mA specification)

- ○ ○ ○

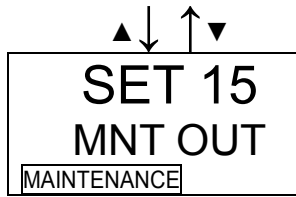

⇔
SET

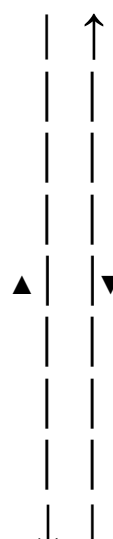
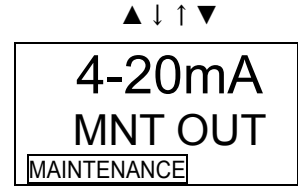
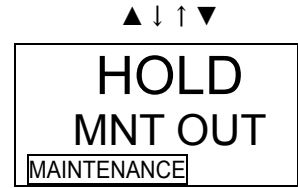
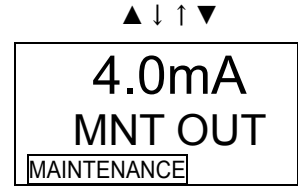
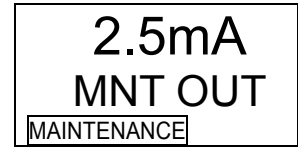

SET 16. MA 4-20

Adjust the external output (4 - 20 mA).
 Adjust the output (%) by pressing the ▲ or ▼ key, and then press the SET key to confirm the value.
 (It must be adjusted to the upper unit or the ammeter.)
 After adjustment of 4 mA is completed, perform the adjustment of 20 mA.
 (Press the MODE key to skip this menu.)
 (4 - 20 mA specification)

- ○ ○ ○



⇔
SET

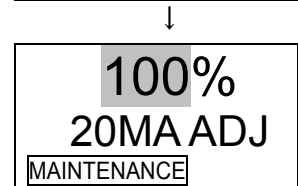
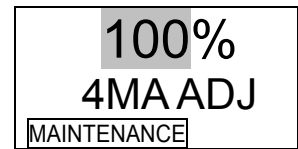

SET 17. BK LIGHT

Set the backlight.
 Select either ON/SAVE, and then press the SET key to confirm the selection.
 When ON is selected, the backlight lights up continuously.
 When SAVE is selected, the backlight is usually turned off, but lights up only during an operation or event.

- ○ ○ ○

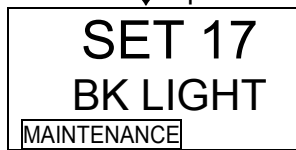

⇔
SET

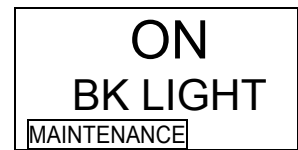

SET 18. ETHERNET

This is a setting screen of the ETHERNET setting.

- ○ ○ ○



⇔
SET



SET 19.PUMP CK

Set the pump drive level diagnosis.

Select either ON/OFF, and then press the SET key to confirm the selection.

When ON is selected, the message "FLOW" is displayed if the flow rate is sufficient even though the pump drive level is low. (A function to check the conditions for applying pressure, etc.)



**SET 19
PUMP CK**
MAINTENANCE

⇔
SET

**ON
PUMP CK**
MAINTENANCE

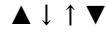

**OFF
PUMP CK**
MAINTENANCE

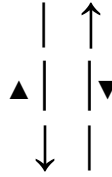

To

SET 0. ADDRESS

<Date/Time Setting "2-10" - "SET 1">

Date/Time Setting

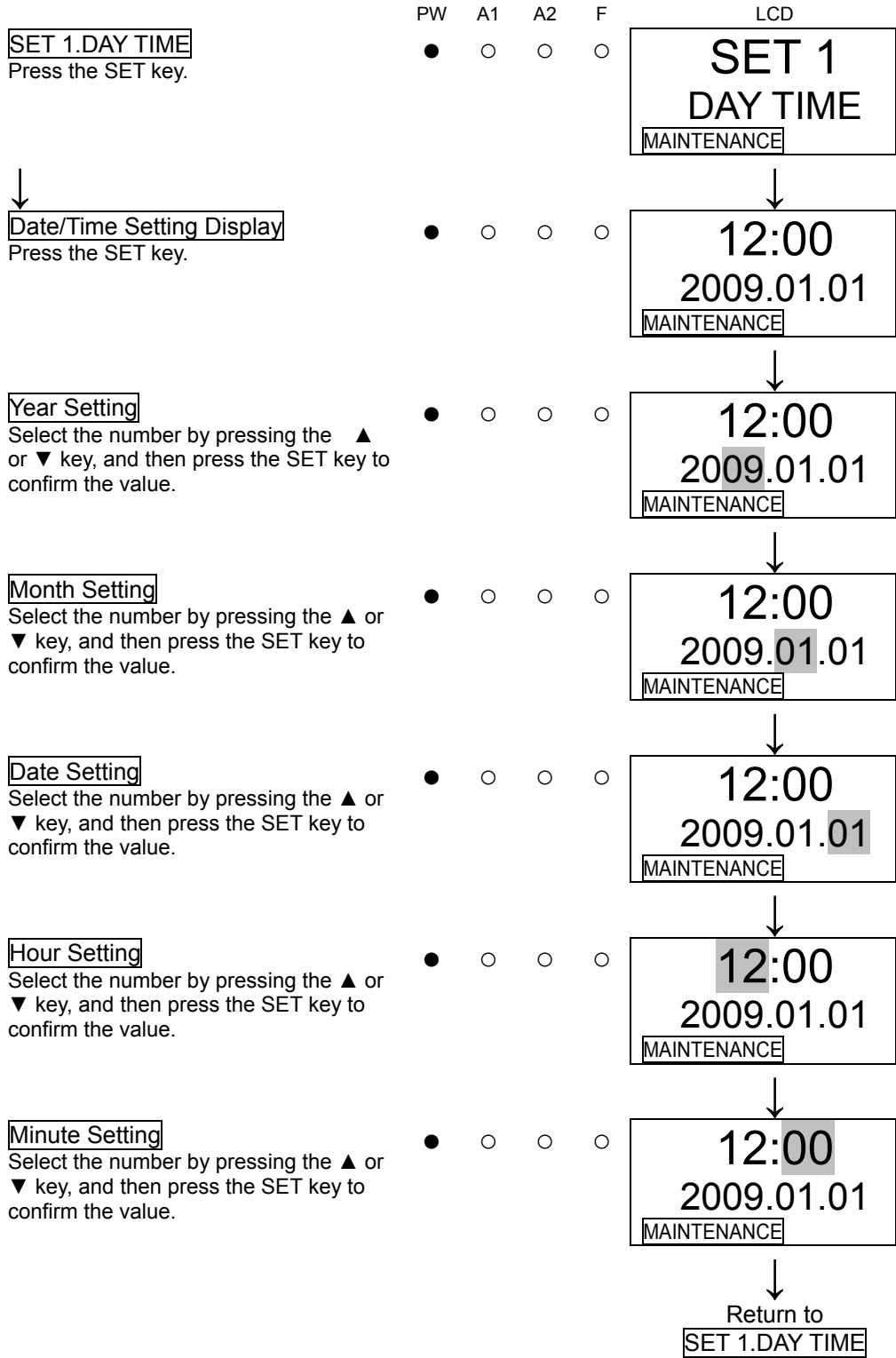

* In the Date/Time Setting mode, press the MODE key to cancel this menu and go back to the previous setting.

<Energized/De-Energized Contact Setting "2-10" - "SET 6">

Energized/De-Energized Contact Setting

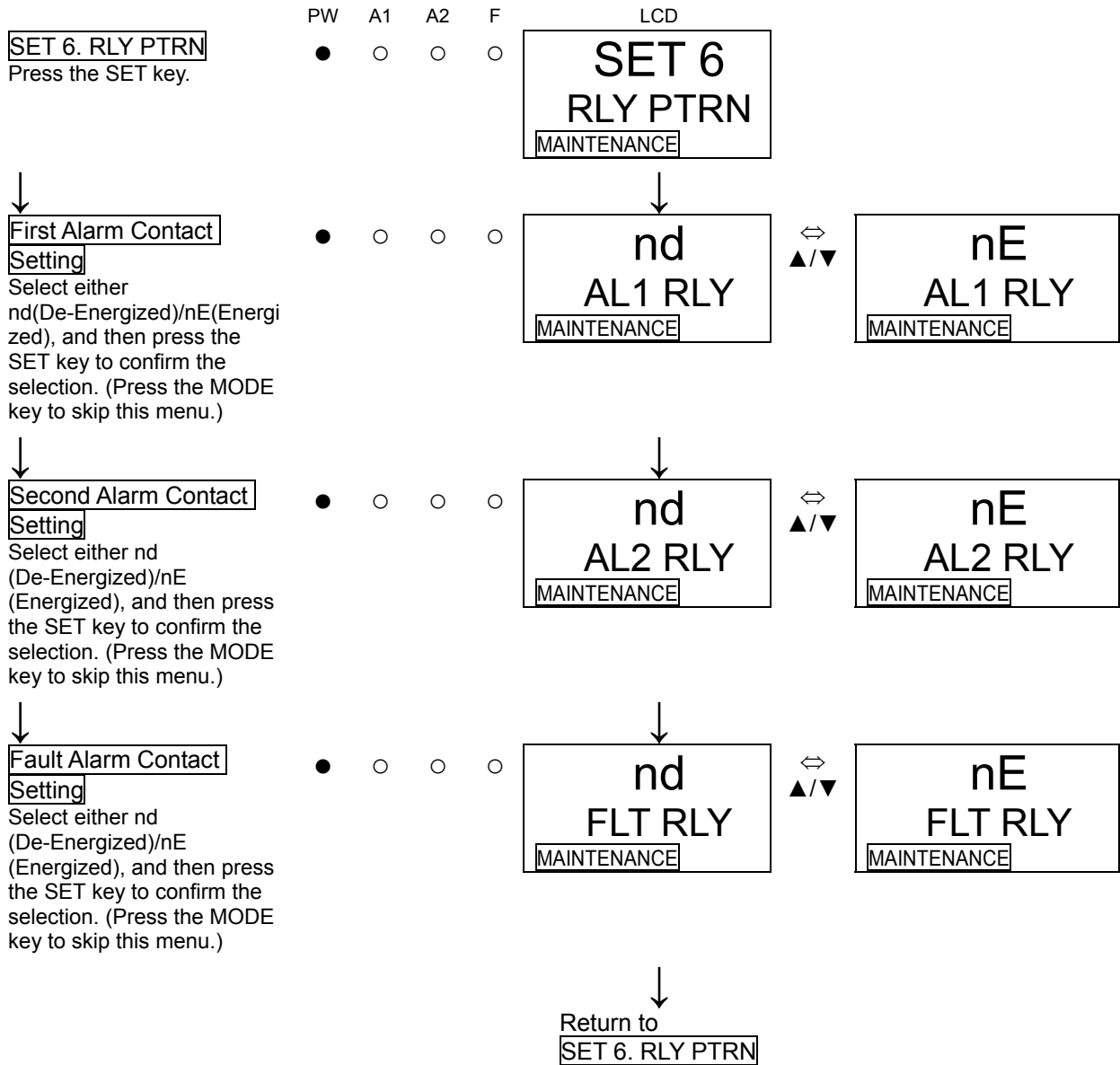

NOTE

When De-energized is selected, the relay is energized and activated in response to an alarm (de-energized at a normal environment).

- When the contact "a" is used, it is open at a normal environment while closed in response to an alarm.
- When the contact "b" is used, it is activated conversely.

When Energized is selected, the relay is energized at a normal environment (de-energized in response to an alarm).

- When the contact "a" is used, it is closed at a normal environment while open in response to an alarm. In addition, it is closed when the power is OFF.
- When the contact "b" is used, it is activated conversely.

<ETHERNET Setting "2-10" - "SET 18">

<<ETHERNET Setting>>

SET 18. ETHERNET
Press the SET key.

PW A1 A2 F

LCD

SET 18
ETHERNET
MAINTENANCE



MAC Address Check

There are MAC addresses from MAC1 to MAC6. Select one using ▲ and ▼ keys and display them one by one in the same way.

* MAC addresses are fixed values unique to the unit.

00
MAC 1
MAINTENANCE

▲↓ ↑▼
(MAC2 ~ MAC6)

IP Address Setting

Select the number by pressing the ▲ or ▼ key, and then press the SET key to confirm the value.

There are IP addresses from IP1 to IP4. Select one using ▲ and ▼ keys and set them one by one in the same way.

0
IP 1
MAINTENANCE

⇔ SET

255
IP 1
MAINTENANCE

▲↓ ↑▼
(IP2 ~ IP4)

Subnet Mask Setting

Select the number by pressing the ▲ or ▼ key, and then press the SET key to confirm the value.

There are subnet masks from SUB1 to SUB4. Select one using ▲ and ▼ keys and set them one by one in the same way.

0
SUB 1
MAINTENANCE

⇔ SET

255
SUB 1
MAINTENANCE

▲↓ ↑▼
(SUB2 ~ SUB4)

Default Gateway Setting

Select the number by pressing the ▲ or ▼ key, and then press the SET key to confirm the value.

There are default gateways from DEF1 to DEF4. Select one using ▲ and ▼ keys and set them one by one in the same way.

0
DEF 1
MAINTENANCE

⇔ SET

255
DEF 1
MAINTENANCE

▲↓ ↑▼
(DEF2 ~ DEF4)

▲↓ ↑▼

DHCP Setting

Select either ON/OFF, and then press the SET key to confirm the selection. When ON is selected, an IP address is automatically obtained from the DHCP server. In this case, the IP1 to IP4, SUB1 to SUB4, and DEF1 to DEF4 settings are disabled.

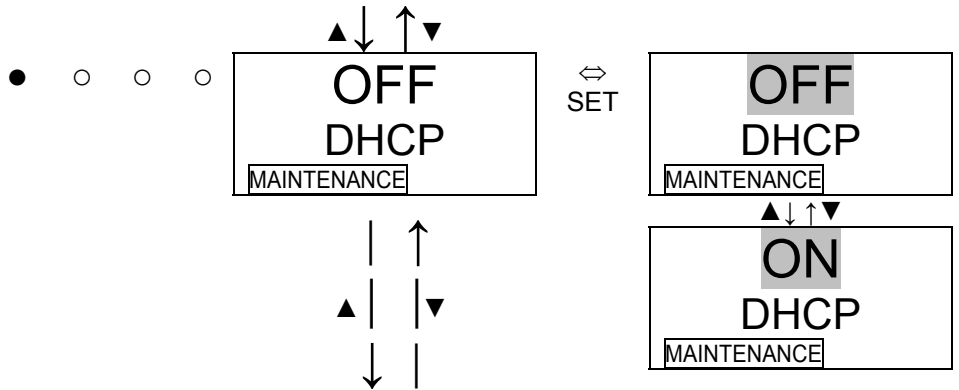

Setting Result Record

To record the results of setting made in the above, press the SET key.

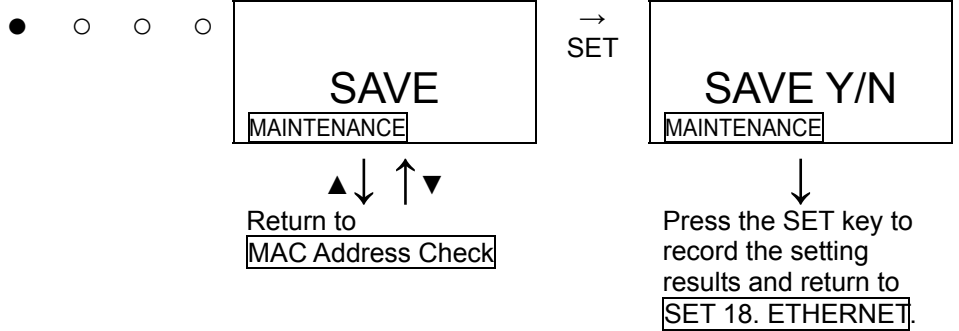

* In ETHERNET mode, it is necessary to record setting results after all the settings have been selected. Press the MODE key before completion to undo all the changes that have been made.

NOTE

It takes 10 seconds or more for the address settings to be recorded and for the settings to take effect on the system. (Particularly for DHCP, the time it takes depends on the environment.) While the settings are putting into effect, "0" is displayed for all of MAC1 - 6, IP1 - 4, SUB1 - 4, and DEF1 - 4, and none of the Ethernet functions is available.

7-3. Gas calibration method

Perform a gas calibration in each mode (zero adjustment mode and span adjustment mode) using the calibration gas.

- Zero adjustment gas (collected in a gas sampling bag)
- Span adjustment gas (collected in a gas sampling bag)
- Gas sampling bags



WARNING

After the adjustment is completed, do not forget to press the MODE key to return to the detection mode.

<Zero Adjustment "2-1">

This is used to perform the zero adjustment.



WARNING

When the zero adjustment is performed in the atmosphere, check the atmosphere for freshness before beginning the adjustment. If other gases exist, the adjustment cannot be performed properly, thus leading to dangers when the gas leaks.

NOTE

Before starting the zero adjustment, let the detector draw the zero adjustment gas and wait until the indicator is stabilized.

Zero Adjustment

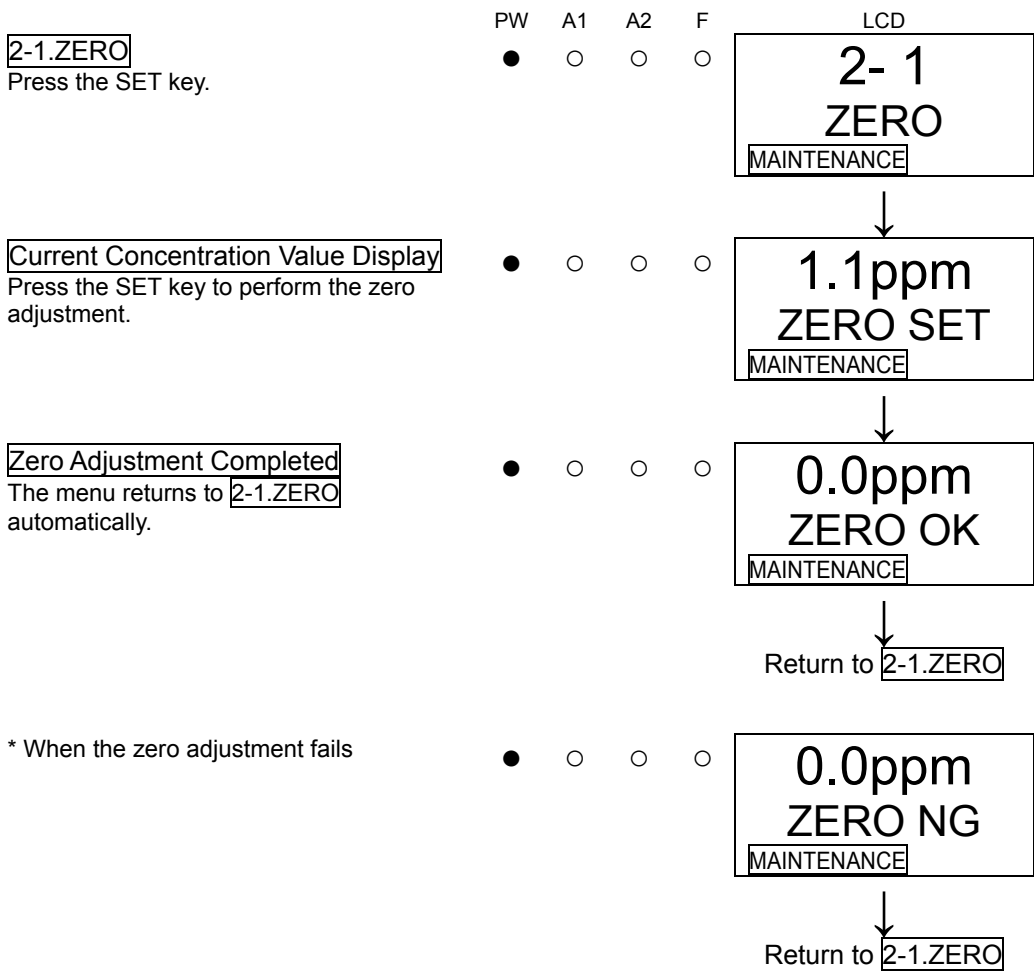

This is used to perform the span adjustment. For the oxygen deficiency alarm specification (OSU - 0 - 25 vol%), this is the same as "1-1".

Span Adjustment Display

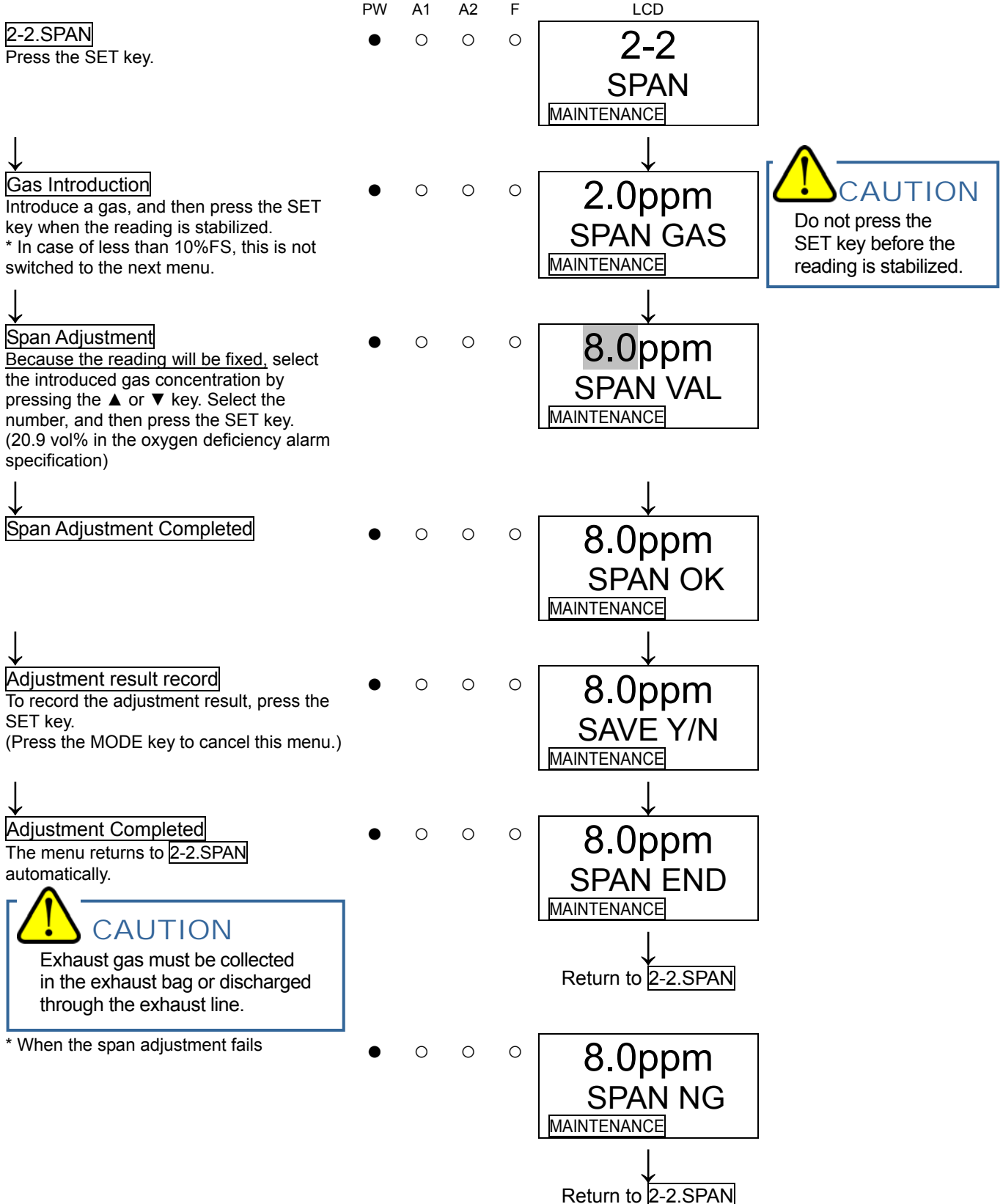

7-4. Other adjustments/Cleaning method

<Flow Rate Manual Adjustment "2-6" and Flow Rate Default Set "2-5">

The flow rate of the detector is automatically adjusted to 0.5 L/min. Turning off the auto-adjustment function enables the manual adjustment. (See 2-10 - SET-11)

The manual flow rate adjustment can be performed in the regular maintenance mode "2-6.FLOW".

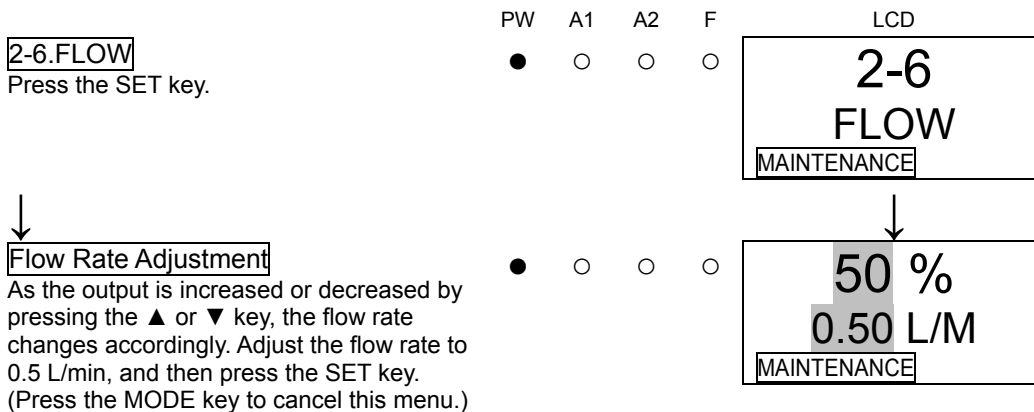

Regardless of the flow rate auto-adjustment or manual-adjustment, when the reading on the flow rate indicator is incorrect (due to aging degradation, improper flow rate default set, or other reasons), it must be set to provide the right flow rate.

To set the Flow Rate Indicator, prepare and connect a flow meter (which indicates 0.5 L/min precisely), and perform the default set with the flow meter while it is indicating 0.5 L/min in the regular maintenance mode "2-5.DEF FLOW".

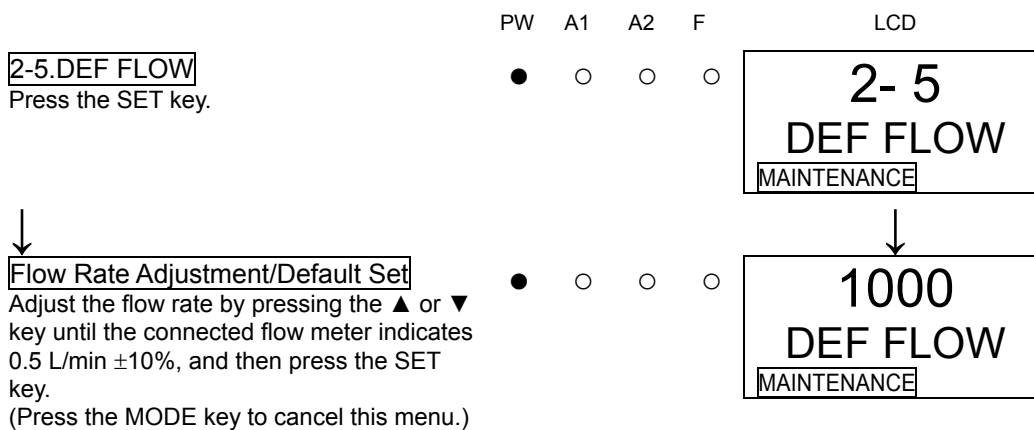

CAUTION

Perform the flow rate default set after checking that the suction volume is 0.5 L/min by using a flow meter.



WARNING

After the adjustment is completed, do not forget to press the MODE key to return to the detection mode.

<Cleaning of Detector>

Clean the detector if it becomes extremely dirty. The detector must be turned off while cleaning it. Use a waste cloth to remove dust. Do not use water or organic solvent for cleaning because they may cause malfunctions.

Because an extremely large amount of dust inside the tube may disturb the gas detection, it must be cleaned with dry AIR, etc.

7-5. How to replace parts

<Replacement of Consumables>

Sensor Unit Replacement

Replace the sensor unit as shown in the figure. Push the two buttons at the top of the main unit together to open the front cover. (Pushing only either one button cannot open the cover, but then pushing the other can open it.)

* The front cover opens about 90 degrees at first. You can push it down to 180 degrees.

Hold the convexed parts on both sides of the sensor unit and pull it out. If the sensor unit is hard to detach, insert a finger into the gap at the top right of the sensor unit and pull it out.

The sensor unit can be replaced in a single step as shown in the figure. When attaching the sensor unit to the main unit, thrust it onto the main unit and make sure that the sensor unit is securely fixed, otherwise it might come off.

After replacing the sensor unit, close the front cover. Be sure to check the click of the front cover to fix it properly, otherwise it might open again.

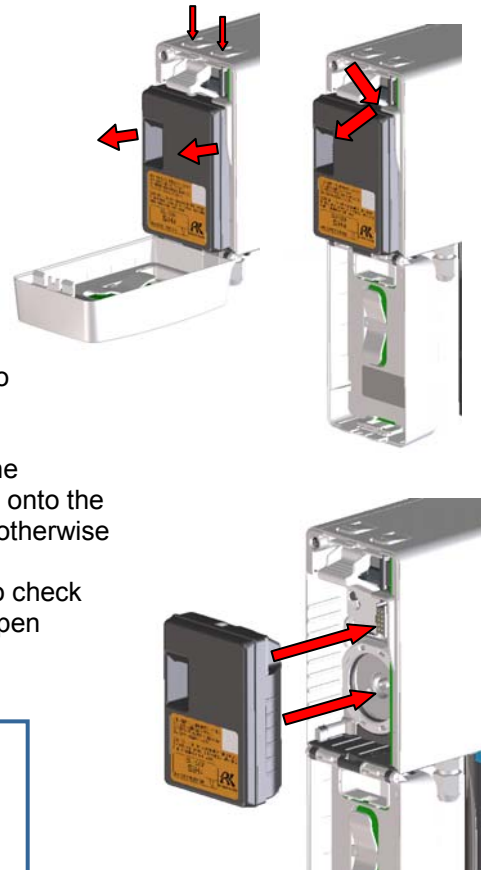

CAUTION

- Turn OFF the power when the sensor unit is replaced.
- After the sensor unit is replaced, always perform a gas calibration (zero adjustment and span adjustment).

External Dust Filter Replacement

Because the external dust filter may gradually get dirty or clogged over the time, it must be replaced regarding the operating conditions. Check the external dust filter, and then replace it as necessary.

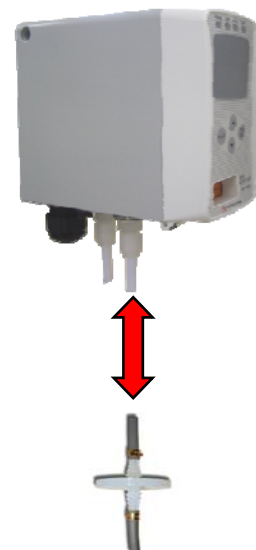

<Replacement of Regular Replacement Parts>

List of recommended regular replacement parts

No.	Item	Maintenance intervals	Replacement intervals	Quantity (pieces/unit)
1	Pump unit	0.5 year	1 - 2 years	1
2	Flow sensor	1 year	5 year	1

Replacement of Pump Unit

Replace the pump unit as shown in the figure. After detaching the sensor unit, push down to open the pump stopper. Pinch the part labeled "PULL" at the top of the pump unit, and pull it out.

The pump unit can be replaced in a single step as shown in the figure. When attaching the pump unit to the main unit, position the grooves of the pump unit at the rails of the main unit and push the pump unit. Do not push the center diaphragm. Push the part labeled "PULL". And as the connecting point (flow path) of the pump unit is greased, be sure to check any dust.

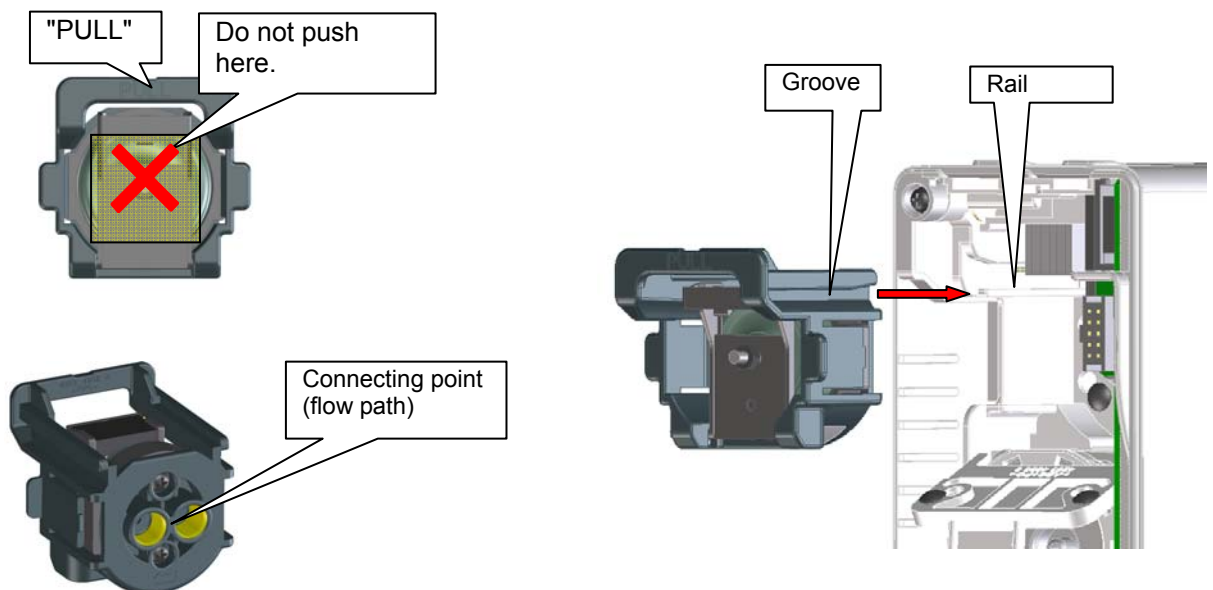
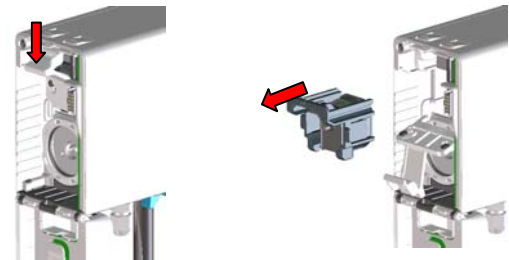

Replacement of Flow Sensor

After the flow sensor is replaced, the operation must be checked by a qualified service engineer.

For the stable operation of the detector and safety, ask a qualified service engineer to take care of replacement of the parts whose operation must be checked. Please contact our sales department.

8

Storage, Relocation and Disposal

8-1. Procedures to store the detector or leave it for a long time

The detector must be stored under the following environmental conditions.

- In a dark place under the normal temperature and humidity away from direct sunlight
- In a place where gases, solvents or vapors are not present

8-2. Relocate

When the detector is relocated, select a new place in accordance with "Precautions for installation site" and "2-2. How to install".

For information on wiring and tubing, see "2-3. How to wire" and "How to tube". The unpowered time must be minimized when the detector is relocated.



CAUTION

- When you use a relocated or stopped/stored detector again, do not forget to perform a gas calibration. For information on readjustment including gas calibration, please contact our sales department.

8-3. Disposal

- A used sensor unit must be returned to us. Please return the sensor unit to our sales department.
- If liquid is leaked from the electrochemical type sensor unit (ESU) or galvanic cell type sensor unit (OSU), do not touch the liquid. The sensor unit must be put into a plastic bag to prevent leaking.
If liquid is leaked from the sensor of the detector, turn "off" the power and contact our sales department immediately.
- Because the pyrolysis-particle type sensor unit (SSU) contains a small amount of radioactive materials, it must be transported appropriately (as a L-type package). When the sensor unit is returned to us, it must be handled by a transportation company which can handle L-type packages.
- When the detector is disposed of, it must be treated properly as an industrial waste in accordance with the local regulations.



WARNING

- Do not disassemble the electrochemical type sensor unit (ESU) or the galvanic cell type sensor unit (OSU) because they contain electrolyte.
Electrolyte may cause severe skin burns if it contacts skin, while it may cause blindness if it contacts eyes. If electrolyte is adhered on your clothes, that part on your clothes is discolored or its material is decomposed. If contact occurs, rinse the area immediately with a large quantity of water.
- The pyrolysis-particle type sensor unit (SSU) must be returned to us in accordance with its "Safety Manual". We will properly dispose of it.

Troubleshooting

The troubleshooting does not explain the causes of all the malfunctions which occur on the detector. This simply helps to find the causes of malfunctions which frequently occur. If the detector shows a symptom which is not explained in this manual, or still has malfunctions even though remedial actions are taken, please contact our sales department.

NOTE

To use the pyrolyzer unit (PLU-70), also refer to the separate operating manual.

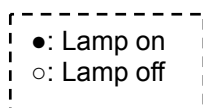

<Abnormalities on Unit>

Symptom/Display	FAULT	Causes	Actions
<u>Impossible Power ON</u>	-	The power switch is turned off.	Turn ON the power switch.
		Abnormalities/momentary blackout of power supply system	Provide the rated voltage. Check the UPS, power supply line filter and insulation transformer, and then take additional measures.
		Improper installation of the main unit	Check whether the main unit is properly attached to the wall-mounted unit.
		Cable abnormalities (open circuit/not connected/short circuit)	Check the wiring of detector and related devices around it.
<u>Abnormal Operations</u>	○	Disturbances by sudden surge noise, etc.	Turn off and restart the detector. If such a symptom is observed frequently, take appropriate measures to eliminate the noise.
<u>Incorrect Flow Rate Indicator</u> (Specified Value Display does not correspond to 0.5 L/min.)	○	Improper flow rate default set	Seemingly performed an improper default set, i.e., performed a default set of flow rate on the detector when the flow rate is not 0.5 L/min. Prepare another flow meter and perform the flow rate default set again. <u>If such a symptom is observed frequently, the flow sensor is seemingly malfunctioning. Thus, it must be replaced. Please contact our sales department.</u>
<u>Sensor Unit Abnormalities</u> <u>E-1 SENSOR</u>	●	The unit is not connected or improperly connected.	Check whether the sensor unit is connected and the connectors of the unit are securely fastened.
		Errors in communication with the unit	Replace the sensor unit with a new one.

Symptom/Display	FAULT	Causes	Actions
		Zero drift caused by environmental changes or aging degradation is out of the range of zero follower.	Perform the zero adjustment. If the symptom persists after the zero adjustment, replace the sensor unit with a new one.
		Faults of the unit itself	Check the sensor unit and replace it with a new one. If it is apparently damaged, do not touch it with bare hands and handle it carefully.
Flow Rate Warning FLOW	○	Unstable flow caused by deteriorated performance of the pump	Seemingly the pump is worn out and its performance is deteriorated. Although gas detection can be performed under this condition, the pump unit must be replaced as soon as possible.
		Unstable flow caused by clogged dust filter	Replace the dust filter.
		Unstable flow caused by bended or clogged suction tube or exhaust tube	Fix the defective parts.
		Pressure difference is present in the sampling condition. (The flow rate is ensured even though the pump drive level is low.)	In some sampling conditions (presence of pressure difference between IN and OUT), the flow rate is ensured even though the pump drive level is low. Although the detector can be used in such a situation, the diagnosis function of its pump drive level issues this message. You can disable this function to eliminate the message. (See "7-2. Maintenance mode".) Check the operating conditions before taking actions. * If the flow rate indicator is incorrect, the message may be displayed even though pressure difference is not present.
		Abnormalities are found in regular maintenance of the flow sensor.	Seemingly the performance of the flow sensor is deteriorated. In this case, the flow rate may not be in the range of 0.5 L/min±10% even though the flow rate indicator indicates the specified value. Although gas can be detected provided that flow loss (fault alarm) does not occur, the flow sensor must be replaced to fix the symptom. Please contact our sales department.
Flow Rate Abnormalities E-5 FLOW	●	Protective rubber cap is not removed.	Remove the protective rubber cap from GAS IN and GAS OUT.
		Broken pump	Replace the pump unit.
		Flow loss caused by clogged dust filter	Replace the dust filter.
		Flow loss caused by bended or clogged suction tube or exhaust tube	Fix the defective parts.
		Open circuit or defective connection of flow sensor	Please contact our sales department.
Communication Abnormalities E-6 (NT specification/ET specification)	○	Communication cable abnormalities	Check the wiring of detector and related devices around it.
		Disturbance by external noise	Turn off and restart the detector. If such a symptom is observed frequently, take appropriate measures to eliminate the noise.
Clock Abnormalities E-9	○	Abnormalities of the clock inside the detector	Make a setting of Date/Time. Note that when the sensitivity correction function of ESU is used, correction may not be made properly. If such a symptom is observed repeatedly, the built-in clock is seemingly malfunctioning. Thus, it must be replaced. Please contact our sales department.

Symptom/Display	FAULT	Causes	Actions
<u>System Abnormalities</u> <u>E-9 SYSTEM</u>	●	The rated voltage is not supplied to the detector.	Check the power supply, and supply the rated voltage.
		Abnormalities of ROM, RAM, or EEPROM inside of the detector	Please contact our sales department.

<Abnormalities of Readings>

Symptoms	Causes	Actions
<u>The reading rises (drops) and it remains so.</u>	Drifting sensor	Perform the zero adjustment (AIR adjustment).
	Presence of interference gas	Disturbances by interference gases, such as solvents, cannot be eliminated completely. For information on actions, such as removal filter, please contact our sales department.
	Slow leak	A very small amount of the gas to be detected may be leaking (slow leak). Because ignoring it may cause dangers, take a remedial measure, i.e., taking actions the same as those for the gas alarm.
	Environmental changes	Perform the zero adjustment (AIR adjustment). In particular, the galvanic cell type is affected by the air pressure.
<u>A gas alarm is triggered despite of no gas leak and no other abnormalities at the detection point.</u>	Presence of interference gas	Disturbances by interference gases, such as solvents, cannot be eliminated completely. For information on actions, such as removal filter, please contact our sales department.
	Disturbance by noise	Turn off and restart the detector. If such a symptom is observed frequently, take appropriate measures to eliminate the noise.
	Sudden change in the environment	When the environment (temperature, etc.) changes suddenly, the detector cannot adjust to it and is affected by it. In some cases, the detector triggers an indication alarm. Because the detector cannot be used under sudden and frequent environmental changes, you must take any preventive actions to eliminate them.
<u>Slow Response</u>	Clogged dust filter	Replace the dust filter.
	Bended or clogged suction tube or exhaust tube	Fix the defective parts.
	Condensation is formed inside the suction tube.	Fix the defective parts.
	Deteriorated sensor sensitivity	Replace the sensor unit with a new one.
<u>Sensitivity Calibration Impossible</u>	Improper calibration gas concentration	Use the proper calibration gas.
	Deteriorated sensor sensitivity	Replace the sensor unit with a new one.

10

Product Specifications

10-1. Product specifications

<Common Specifications>

Concentration Display	Character LCD (Digital and Bar Meter Display)
Suction Flow Rate	0.5L/min \pm 10%
Power Display	POWER lamp on (green)
Displays	Gas name display/Flow rate indicator/Mode display/Communication status display/Pyrolyzer connection display
Gas Alarm Display	First: ALM1 lamp on (Red)/Second: ALM2 lamp on (Red)
Gas Alarm Activation	Non latching (Auto-reset)
Gas Alarm Contact	No-voltage contact 1a or 1b (2 step independent) de-energized (energized at a time of alarm) or energized (de-energized at a time of alarm)
Fault Alarm/Self Diagnosis	System abnormalities/Sensor abnormalities/Flow Rate abnormalities/Communication abnormalities/Pyrolyzer abnormalities
Fault Alarm Display	FAULT lamp on (Yellow)/Detail display
Fault Alarm Activation	Non latching (Auto-reset)
Fault Alarm Contact	No-voltage contact 1a or 1b de-energized (energized at a time of alarm) or energized (de-energized at a time of alarm)
Contact Capacity	125 VAC - 0.25A/24 VDC - 0.5A (Resistant load)
Recommended Contact Cable	Cable of CVV, etc. (1.25sq) - max. 6-core
Functions	White backlight/Alarm delay/Suppression/Zero follower/Sensitivity correction/Flow control/Calibration history/Alarm trend history/Event history
Tube Connecting Hole	Rc1/4 (O.D Φ 6-1t half-union for Teflon tube<PP>supplied)
Initial Clear	Approx. 25 seconds
Structure	Box type/Wall mounted type
External Dimensions	Approx. 70(W)x120(H)x145(D) mm (projection portions excluded)
Weight	Approx. 0.9 kg
Outer Color	Gas detector: grey Front door: white

<Specifications for Each Model>

Model	GD-70D	GD-70D-NT	GD-70D-ET
Transmission System	3-wire type analog transmission (Common cable for power and signal <Power, Signal, Common>) or 2-wire type analog transmission	2-wire type DC power-line communication	Ethernet (10BASE-T/100BASE-TX)
Transmission Specification	4 - 20 mA DC (no-insulation/load resistance under 300Ω)		
Transmission Cable	Shielded cable of CVVS, etc. (1.25sq) 3-core or 2-core	Shielded twisted-pair cable (1.25sq) of KPEV-S, etc. - 1P	Ethernet cable (category 5 or higher)
Power Cable	Cable of CVV, etc.(1.25sq) - 2-core (Those for 3-wire type are common with the transmission cable.)	(Common with the transmission cable)	Cable of CVV, etc.(1.25sq) - 2-core (Common with the transmission cable for PoE connection)
Power Supply	24VDC \pm 10%	24VDC \pm 10% (Dedicated line by blocking filter)	24 VDC \pm 10% or PoE connection

<Specifications for Each Principle>

	ESU	ESU + PLU *1	SSU + PLU *1
Detection principle	Electrochemical		Pyrolysis-particle
Gas to be detected	Toxic gas *2	NF3	Toxic gas *2
Detection range	Depending on the gas to be detected	0 - 30 ppm	Depending on the gas to be detected
Detection system	Pump suction type	Pump suction type/pyrolysis type	
Alarm setpoint	Depending on the gas to be detected	10 ppm(1st) 20 ppm(2nd)	Depending on the gas to be detected
Alarm accuracy (under the same conditions)	Within $\pm 30\%$ *3		
Response Time (under the same conditions)	60 seconds or less *4		
Alarm type	Two step alarm (H-HH)		
Power consumption	Approx. 1.5 W (Max. 4 W)		
Power consumption (ET)	24 V: Approx. 2.5 W (Max. approx. 4.5 W) PoE: Approx. 4 W (Max. approx. 6.5 W)		
Operating temperatures (at a constant condition)	0 - 40°C		
Operating humidities (Non-condensing)	30 - 70%RH		30 - 80%RH
	NCU	SGU	OSU *5
Detection principle	New ceramic	Semiconductor	Galvanic cell
Gas to be detected	Combustible gas	Combustible gas Toxic gas	Oxygen
Detection range	Depending on the gas to be detected	Depending on the gas to be detected	0 - 25 vol%
Detection system	Pump suction type		
Alarm setpoint	Depending on the gas to be detected	Depending on the gas to be detected	18 vol% (1st) 18 vol% (2nd)
Alarm accuracy (under the same conditions)	Within $\pm 25\%$ *3	Combustible: within $\pm 25\%$ *3 Toxic: within $\pm 30\%$ *3	Within ± 1 vol% (Accuracy of the reading: within ± 0.7 vol%)
Response Time (under the same conditions)	30 seconds or less *4	Combustible: 30 seconds or less *4 Toxic: 60 seconds or less *4	5 seconds or less *6 (90% response: within 30 seconds)
Alarm type	Two-step alarm (H-HH)		Two-step alarm (L-LL, L-H)
Power consumption	Approx. 3 W (Max. 5.5 W)	Approx. 2.5 W (Max. 5 W)	Approx. 1.5 W (Max. 4 W)
Power consumption (ET)	24 V: Approx. 4 W (Max. approx. 6 W) PoE: Approx. 5 W (Max. approx. 8 W)	24 V: Approx. 3.5 W (Max. approx. 5.5 W) PoE: Approx. 5 W (Max. approx. 6.5 W)	24 V: Approx. 2.5 W (Max. approx. 4.5 W) PoE: Approx. 4 W (Max. approx. 6.5 W)
Operating temperatures (at a constant condition)	0 - 40°C		
Operating humidities (Non-condensing)	Below 95%RH		

- *1 Pyrolyzer unit combination specification. For information on the specifications of the pyrolyzer unit (PLU-70), see the separate operating manual.
- *2 The operating temperature/humidity may be different depending on the gas to be detected.
- *3 To the alarm setpoint value
- *4 By providing the gas 1.6 times the alarm setpoint (excluding delay in the tube and in the communication)
- *5 Oxygen deficiency specification.
- *6 By letting the detector detect the gas of 10 - 11 vol% (excluding delay in the tube and in the communication).

NOTE

For information on other specifications such as oxygen leak specifications (OSU), please contact us.

10-2. Standard Accessories

- Operating manual
- Protective rubber cap
- Dedicated handling lever
- Dust filter
- Interference gas removal filter (to be supplied with some sensor units)

10-3. Detection principle

<Electrochemical Type>

The electric potential between the working electrode and reference electrode is kept at a certain level by a potentiostat circuit.

The gas to be detected is electrolyzed directly at the working electrode. Because the electric current generated there is proportional to the gas concentration, the gas concentration can be known by measuring the electric current flown between the working electrode and the opposite electrode.

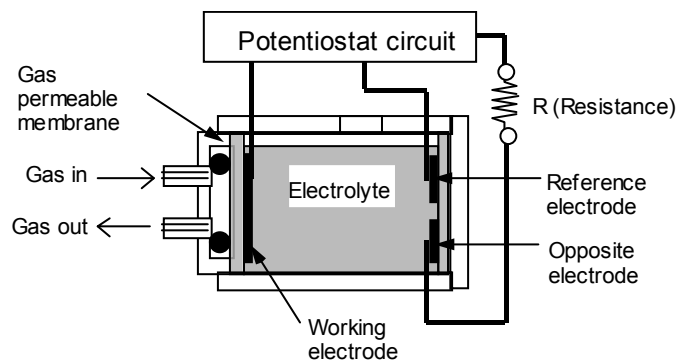

Structure diagram

Special precautions for this principle

1. The detector may be interfered by gases other than the gas to be detected, solvents, vapors, etc. Please note that the alarm may be triggered by interference. In addition, it may be fluctuated by environmental (temperature, humidity, etc.) changes in the installation site.
2. The alarm must be set within a range where the performance of the detector can be ensured. In facilities compliant with the High Pressure Gas Safety Act, an alarm setting below our standard alarm setpoint (threshold limit value) may trigger a false alarm.
3. This is a safety unit, not a control unit. The alarm contact output of the detector must be used for an external alarm lamp/buzzer, while the alarm signal output must be used for an indicator or external recorder. If these outputs are used to control other units, we shall not be responsible for any malfunctions.
4. Because the contact point of the gas detector sensor is made of porous polymeric membrane, the water repellency of the membrane is deteriorated by solvents, thus causing an electrolyte leak from its inside. Do not use solvents near the detector. If you must use a solvent for unavoidable reasons, attach the recommended filter to the inlet of the gas detector while using the solvent and for one hour after that.
5. For maintenance of the detector, it must go through a regular maintenance, including replacement and adjustment of the regular replacement parts as specified in the operating manual. In addition, because this is a safety unit, it is recommended that a regular maintenance and gas calibration are performed for every six months in accordance with the regulations.

<Pyrolysis-Particle Type>

When the gas to be detected is heated to several hundred degrees, particulate solid oxides are formed.

This is a sensor to detect particles formed in such a way by using the α ray absorbing method.

Structure

This unit consists of a pyrolyzer which heats gas to several hundred degrees and a particle detector which detect oxides. The pyrolyzer has a quartz pipe at its center covered with a heating element and a heat insulator around it.

The particle detector consists of the measurement cell in which α ray always generates ion current and the compensation cell which has the identical structure (gas is not introduced).

(Pyrolyzer)

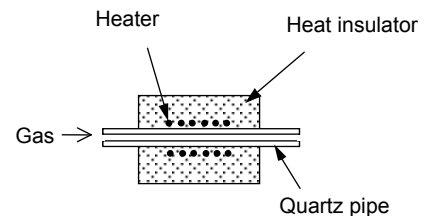

Principle

When most of organic metal (MO) gas, such as TEOS, are heated, particulate oxides are formed. Sample gas which is decomposed to oxides in the Pyrolyzer is introduced into the particle detector.

Inside of the measurement cell of the particle detector, the α ray radiation source *1 ionizes the air and generates ion current.

Ion current is also generated in the compensation cell, and its ratio is maintained at a certain level in both the measurement cell and the compensation cell when no gas is present. When particles are introduced into the measurement cell, the particles adsorb ions, thus reducing the ion current. Its ratio to the compensation cell changes, which can be obtained from the detector.

(Particle detector)

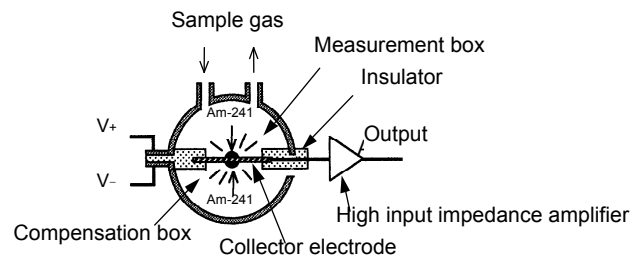

* 1: Am-241 37kBq

Special precautions for this principle

1. The detector may be interfered by gases other than the gas to be detected, and vapors. Please note that the alarm may be triggered by interference. In addition, it may be fluctuated by environmental (temperature, humidity, etc.) changes in the installation site.
2. The alarm must be set within a range where the performance of the detector can be ensured. In facilities compliant with the High Pressure Gas Safety Act, an alarm setting below our standard alarm setpoint may trigger a false alarm.
3. This is a safety unit, not a control unit. The alarm contact output of the detector must be used for an external alarm lamp/buzzer, while the alarm signal output must be used for an indicator or external recorder. If these outputs are used to control other units, we shall not be responsible for any malfunctions.
4. The gas detection sensor unit attached to the detector contains a small amount of radioactive materials. Do not disassemble it, or dispose of it like other wastes. (For information on how to handle the sensor, see the "Safety Manual".)
5. For maintenance of the detector, it must go through a regular maintenance, including replacement and adjustment of the regular replacement parts as specified in the operating manual. In addition, because this is a safety unit, it is recommended that a regular maintenance and gas calibration are performed for every six months in accordance with the regulations.

The detector has the pyrolysis-particle type sensor, which is a radioisotope-equipped unit. It is examined in accordance with the regulations on "Article 12 - 3 of Act on Prevention of Radiation Disease Due to Radioisotopes, etc." (Nuclear Safety Technology Center, a certification and registration body), and certified as a specified designing certification device, which is regarded as a unit causing little radiation damage.

(Certificate Number: ㊦091)

No registrations have to be made to use a gas detector with the pyrolysis-particle type sensor installed (as far as it is used in accordance with this operating manual).

When the pyrolysis-particle type sensor is used as a single unit, observe the certification conditions specified in the "Safety Manual".

<Safety Manual>

No.4019 4059 2

The pyrolysis-particle type sensor (SS-1923/1924 and SS-1925 Note 1)) is a radioisotope-equipped unit which uses radioisotope 37 kBq 241-Am.

This pyrolysis-particle type sensor is certified as a specified designing certification unit by Nuclear Safety Technology Center, a certification and registration body causing little radiation damage. (SS-1923/1924 : Certificate Number ㊦027, SS-1925 : Certificate Number ㊦091)

When the sensor is used within Japan, no registrations have to be made Note 2).

However, because the regulations are applied to the sensor, it must be used in accordance with the following certification conditions Note 3).

- Do not disassemble the sensor Note 4).
- The sensor must be installed in our product when it is used. Do not remove it from the product if not necessary.
- When the sensor is detached from the product and is stored, you must take measures to prevent it from being taken out freely, i.e., putting it into the dedicated box we specify, and keeping it in a locked room.
- When the sensor is no longer needed, do not dispose of it, but return it to us.
- The sensor must be handled as a L-type package. It must be put into the dedicated box we specify or integrated into our product which is labeled as a "Radioactive L-type package" when it is transported.
- When the sensor is transported, it must be handled by a transportation company which can handle L-type packages Note 5).

Note 1) SS-1925 indicates the sensor installed in the pyrolysis-particle type sensor unit SSU-1925.

Note 2) When the sensor is used outside of Japan, observe the regulations of the respective country.

Note 3) When the sensor is used in a way not in accordance with the certification conditions, a usage registration must be made to the Minister of Education, Culture, Sports, Science and Technology.

If you find the sensor which is not controlled properly, please let us know.

Note 4) Do not disassemble the pyrolysis-particle type sensor unit SSU-1925 in which SS-1925 is installed.

Note 5) L-type packages can be handled by us and service companies we specify.

Web site on the designing certification: <http://www.mext.go.jp/>



2-7-6 Azusawa Itabashi-ku Tokyo, 174-8744 Japan
 TEL 03-3966-1112
 RIKEN KEIKI CO., LTD.

Safety of the radioisotope ^{241}Am (37 KBq) used in the pyrolysis-particle type sensor

The pyrolysis-particle type sensor installed in the gas detector uses the radioisotope ^{241}Am radiation source ($18.5 \text{ KBq} \times 2 = 37 \text{ KBq}$).

A specified designing certification device must satisfy the specified threshold for "1 cm dose equivalent rate at a point 10 cm away from the surface of the device" as a certificate condition, which is the following value (tolerable amount).

	Tolerable amount
1 cm dose equivalent rate at a point 10 cm away from the surface of the device	$1 \mu\text{Sv}\cdot\text{h}^{-1}$

This detector which uses radioisotope ^{241}Am radiation source ($18.5 \text{ KBq} \times 2 = 37 \text{ KBq}$) has the following 1 cm dose equivalent rate at a point 10 cm away from its surface, meaning that it completely satisfies the certification condition.

1 cm dose equivalent rate at a point 10 cm away from the surface of the sensor (calculated value)

$$D = \frac{Q}{r^2} \cdot \Gamma_{1cm} = \frac{2 \times 18.5 \times 10^{-3}}{(0.1)^2} \cdot 0.00524 = 0.019 \text{ } [\mu\text{Sv}\cdot\text{h}^{-1}]$$

Q : Amount of radioisotope $2 \times 18.5 \times 10^{-3} \text{ [MBq]} = (37 \text{ KBq})$

Γ_{1cm} : 1 cm dose equivalent rate constant of ^{241}Am $0.00524 \text{ } [\mu\text{Sv}\cdot\text{m}^2\cdot\text{MBq}^{-1}\cdot\text{h}^{-1}]$

r : Distance from radiation source 0.1 [m]

It is certified as a safety unit, provided that it is used in accordance with the certification conditions specified in the "Safety Manual".

<New Ceramic Type>

When a combustible gas burns on the surface of a highly active new ceramic oxidation catalyst in catalytic combustion, the new ceramic-type sensor measures resultant temperature changes by measuring the resistance changes in the heat-resistant alloy wire coil.

The sensor consists of two elements: A detecting element having a heat-resistant alloy wire coil with an ultrafine particle (new ceramic) oxidation catalyst sintered on it together with a carrier and a temperature-compensating element with a mixture of gas-inert alumina and glass sintered on it.

When a combustible gas comes into contact with the surface of the detecting element with new ceramic oxidation catalyst sintered on it, the gas burns, causing the temperature to rise. In accordance with this temperature change, there occurs a change in the resistance of a heat-resistant alloy wire coil that constitutes the element. These resistance values are approximately proportional to gas concentrations. From the changes in the resistance values, potential differences are obtained using a bridge circuit and displayed as gas concentrations on the meter.

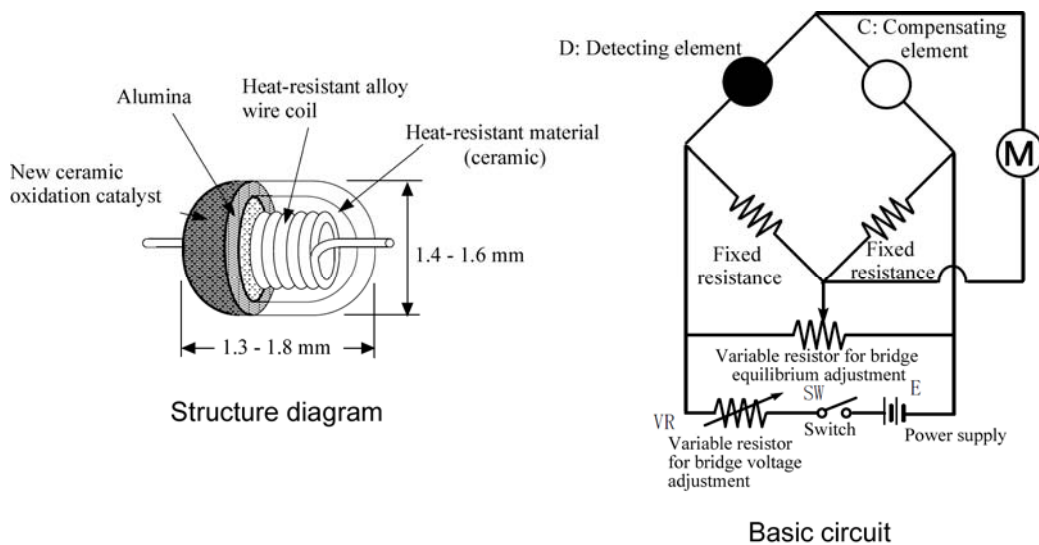

Special precautions for this principle

1. The detector may be interfered by gases other than the gas to be detected, and vapors. Please note that the alarm may be triggered by interference. In addition, it may be fluctuated by environmental (temperature, humidity, etc.) changes in the installation site.
2. The alarm must be set within a range where the performance of the detector can be ensured. In facilities compliant with the High Pressure Gas Safety Act, an alarm setting below our standard alarm setpoint may trigger a false alarm.
3. This is a safety unit, not a control unit. The alarm contact output of the detector must be used for an external alarm lamp/buzzer, while the alarm signal output must be used for an indicator or external recorder. If these outputs are used to control other units, we shall not be responsible for any malfunctions.
4. The gas sensing part of the gas detection sensor installed in this detector is made of metal porous sintered alloy permeated with an oxidation catalyst. If silicon or sulfide compounds are accumulated on the surface of porous sintered alloy, the area of the gas sensing part becomes smaller, which may result in serious deterioration of its sensitivity. For safety reasons, do not use the detector under the presence of silicon or sulfide compounds even though their amount is very small.
5. For maintenance of the detector, it must go through a regular maintenance, including replacement and adjustment of the regular replacement parts as specified in the operating manual. In addition, because this is a safety unit, it is recommended that a regular maintenance and gas calibration are performed every six months in accordance with the regulations.

<Semiconductor Type>

Metal dioxide can measure gas concentration based on changes in the electric conductivity of semiconductor caused by gas accumulated on its surface.

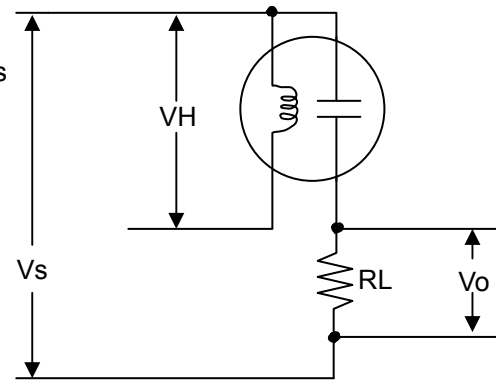

RL: Load resistance V_o : Output voltage
 VH: Heater voltage V_s : Sensor voltage

Special precautions for this principle

1. The detector may be interfered by gases other than the gas to be detected, and vapors. Please note that the alarm may be triggered by interference. In addition, it may be fluctuated by environmental (temperature, humidity, etc.) changes in the installation site.
2. The alarm must be set within a range where the performance of the detector can be ensured. In facilities compliant with the High Pressure Gas Safety Act, an alarm setting below our standard alarm setpoint may trigger a false alarm.
3. This is a safety unit, not a control unit. The alarm contact output of the detector must be used for an external alarm lamp/buzzer, while the alarm signal output must be used for an indicator or external recorder. If these outputs are used to control other units, we shall not be responsible for any malfunctions.
4. The gas sensing part of the gas detection sensor installed in this detector is made of porous sintered alloy. If silicon or sulfide compounds are accumulated on the surface of porous sintered alloy, the area of the gas sensing part becomes smaller, which may results in serious deterioration of its sensitivity. For safety reasons, do not use the detector under presence of silicon or sulfide compounds even though their amount is very small.
5. For maintenance of the detector, it must go through a regular maintenance, including replacement and adjustment of the regular replacement parts as specified in the operating manual. In addition, because this is a safety unit, it is recommended that a regular maintenance and gas calibration are performed for every six months in accordance with the regulations.

<Galvanic Cell Type>

By immersing precious metal and lead in electrolyte and connecting them with a lead wire, a battery can be made (galvanic cell). When oxygen passes through the barrier, deoxidizing reaction occurs at the precious metal electrode while oxidizing reaction occurs at the lead electrode. The electric current generated by this reaction goes through load resistance (thermister), where it is converted into voltage so that it can be read. When the oxygen concentration is decreased, deoxidizing reaction at the precious metal electrode is also decreased, thus lowering the voltage at both ends of the thermister.

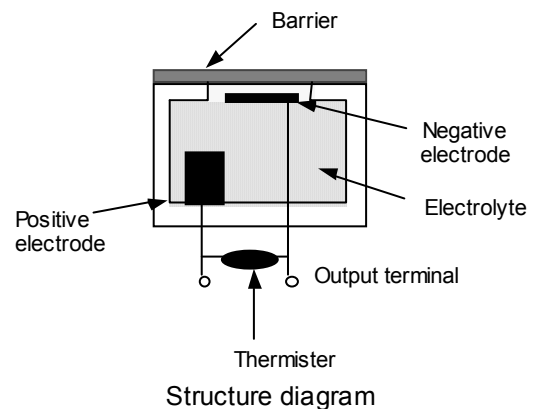

Special precautions for this principle

1. The readings of the detector fluctuate slightly in response to changes in the air pressure. In particular, be careful of alarm activation when a low air pressure is brought in by typhoon. The environmental (temperature, humidity, etc.) changes in the installation site may also have influences on the readings.
2. The alarm must be set within a range where the performance of the detector can be ensured. The standard alarm setpoint value is 18 vol%.
3. This is a safety unit, not a control unit.
The alarm contact output of the detector must be used for an external alarm lamp/buzzer, while the alarm signal output must be used for an indicator or external recorder. If these outputs are used to control other units, we shall not be responsible for any malfunctions.
4. For maintenance of the detector, it must go through a regular maintenance, including replacement and adjustment of the regular replacement parts as specified in the operating manual. In addition, because this is a safety unit, it is recommended that a regular maintenance and sensitivity calibration are performed for every six months.

Definition of Terms

External Dust Filter	When the detector is used in a dusty environment, it is recommended that a dust filter should be attached to its outside. The filter is specified based on the gas to be detected. Please contact our sales department.
vol%	Gas concentration indicated in the unit of one-hundredth of the volume
ppm	Gas concentration indicated in the unit of one-millionth of the volume
ppb	Gas concentration indicated in the unit of one-billionth of the volume
Calibration	Find relationship of the readings, display values or setpoints with the actual values by using the calibration gas.
Maintenance Mode	When maintenance is performed on the detector, the alarm contact is disconnected, and a signal to indicate the maintenance mode status is sent out to the external output signal. As a result, maintenance can be performed on a single unit of the detector.
Initial Clear	The reading is unstable for seconds after the power is turned on. To prevent malfunctions for that period, the alarm contact is deactivated. In addition, a signal to indicate the initial clear status is sent out to the external output.
Zero Suppression	A function to cut off the influences of environmental changes, interference gases, etc.
Alarm Delay Time	A function which temporarily suspends activation to prevent a false alarm caused by noise from its outside.
Inhibit	The gas detection function is temporarily suspended during maintenance, etc. of the detector. This is also called "point skip", which has the same function.
Pyrolyzer Unit	A unit to decompose gases under high temperatures. It pyrolyzes special gases under high temperature to make them detectable.

Warranty Policy

1. We shall provide free repair services for one year after your purchase of the product in case of malfunctions, provided that it is used properly in accordance with the operating manual.
2. Repair services in the following cases shall be charged even though the product is under warranty.
 - (1) Malfunctions caused by improper operation or miss-handling.
 - (2) Malfunctions or damage when repair or modification is made by parties other than us and our service representatives.
 - (3) Malfunctions and damage caused during delivery, relocation, drop, improper storage, etc. after purchase of the product.
 - (4) Malfunctions and damage caused by external factors, such as fire, earthquake, flood, and other natural disasters.
 - (5) Malfunctions caused by other units connected to the detector.
 - (6) Malfunctions caused by products other than the detector.
 - (7) Malfunctions and damage caused when the product is used not in accordance with the specified operating conditions.
 - (8) Replacement of consumables (battery, sensor, etc.) and accessories.
 - (9) No warranty document is presented.
 - (10) Repairing services are provided at a distant location, travel expenses (actual costs) are billed even though the detector is still under warranty. In case of paid repair services, necessary expenses, such as technical fees, replacement parts fees, travel expenses and other expenses are billed.
 - (11) We shall not be responsible for malfunctions and damage caused when the product is used for other purposes, e.g., when the external signal output of the product is used to control other units, and shall not make any compensation for damage (such as incidental damage) caused by this.
 - (12) Regardless of warranty period, we shall not make any compensation for accidents and damage caused by using this product. The compensation shall be made only under the warranty policy of products or parts replacement.
 - (13) The warranty is valid only in Japan.

* The spare parts will be provided for seven years after its discontinuance.